

APLISENS[®]

USER'S MANUAL

SMART PRESSURE AND
DIFFERENTIAL PRESSURE TRANSMITTERS

**PCE-28.Modbus, PRE-28.Modbus,
PCE-28.Modbus16, PRE-28.Modbus16
PCE-28.Modbus-ALW**

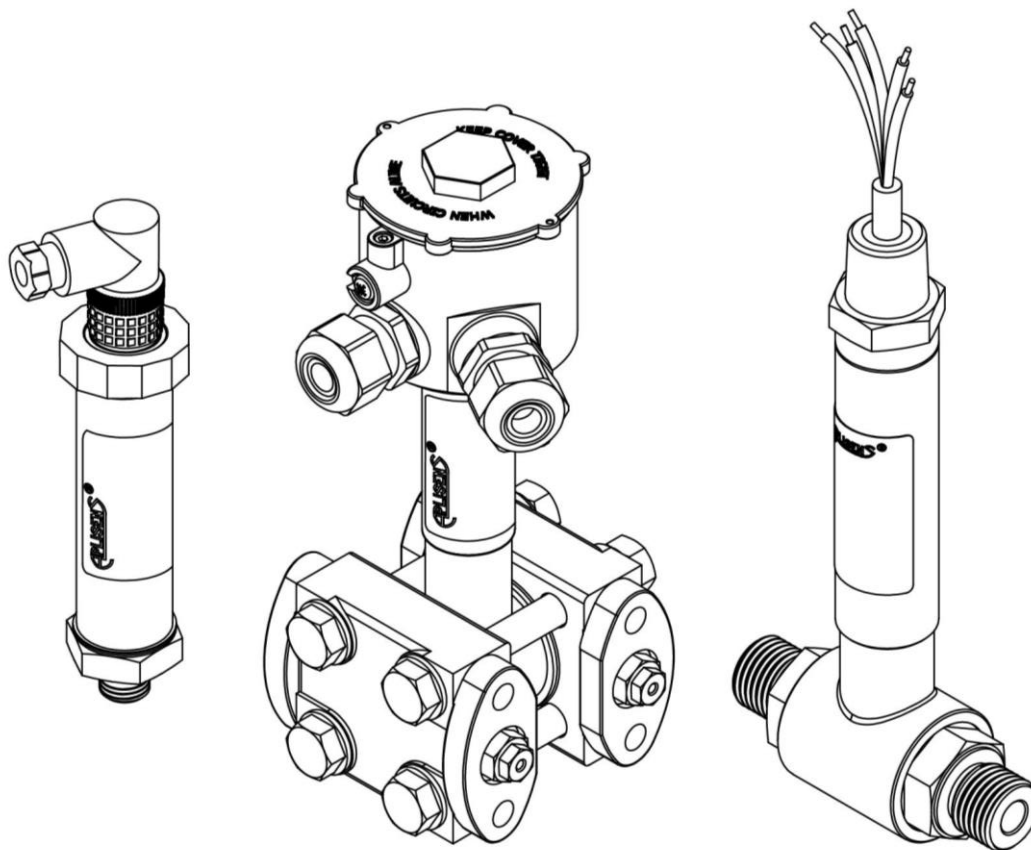

PRODUCT CODE – see: (→ [Transmitter identification](#)).

The QR code or ID number identifies the transmitter and provides quick access to the following documentation on the manufacturer's website: user's manual, explosion-proof device user manual, declarations of conformity and copies of certificates.

PCE-28.Modbus

ID: 0032 0001 0001 0000 0000 0000 0001 16

<https://www.aplisens.pl/ID/003200010001000000000000000116/>

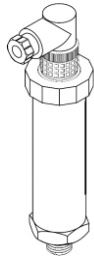

PCE-28.Modbus (Exi)

ID: 0032 0002 0001 0000 0000 0001 0001 33

<https://www.aplisens.pl/ID/003200020001000000000001000133/>

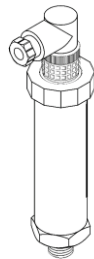

PCE-28.Modbus (Exd)

ID: 0032 0002 0001 0000 0000 0002 0001 81

<https://www.aplisens.pl/ID/003200020001000000000002000181/>



PRE-28.Modbus

ID: 0037 0001 0001 0000 0000 0000 0001 98

<https://www.aplisens.pl/ID/003700010001000000000000000198/>

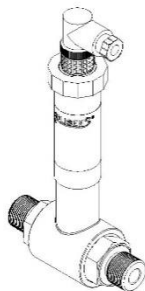

PRE-28.Modbus (Exi)

ID: 0037 0002 0001 0000 0000 0000 0001 0001 18

<https://www.aplisens.pl/ID/00370002000100000000000001000118/>

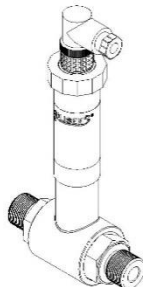

PRE-28.Modbus (Exd)

ID: 0037 0002 0001 0000 0000 0002 0001 66

<https://www.aplisens.pl/ID/00370002000100000000000002000166/>

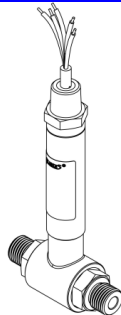

PCE-28.Modbus16 (Exi)

ID: 0069 0001 0001 0000 0000 0001 0001 50

<https://www.aplisens.pl/ID/006900010001000000000001000150>

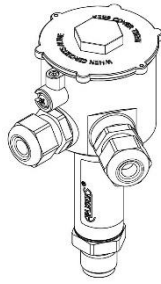

PRE-28.Modbus16 (Exi)

ID: 0070 0001 0001 0000 0000 0001 0001 47

<https://www.aplisens.pl/ID/007000010001000000000001000147>

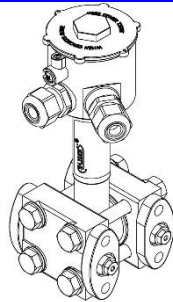



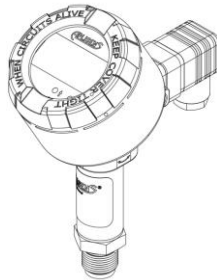

PCE-28.Modbus-ALW

ID: 0068 0001 0001 0000 0000 0000 0001 05

<https://www.aplisens.pl/ID/006800010001000000000000000105>



Symbols used

Symbol	Description
	Warning to proceed strictly in accordance with the information contained in the documentation in order to ensure the safety and full functionality of the device.
	Information particularly useful during installation and operation of the device.
	Information particularly useful during installation and operation of an Ex type device.
	Information on disposal of used equipment.

BASIC REQUIREMENTS AND SAFE USE



The manufacturer will not be liable for damage resulting from incorrect installation, failure to maintain a suitable technical condition of the device or use of the device other than for its intended purpose.

Installation should be carried out by qualified staff having the required authorizations to install electrical and I&C equipment. The installer is responsible for performing the installation in accordance with manual as well as with the electromagnetic compatibility and safety regulations and standards applicable to the type of installation.

In systems with I&C equipment, in case of leakage, there is a danger to staff due to the medium under pressure. All safety and protection requirements must be observed during installation, operation and inspections.

If a malfunction occurs, the device should be disconnected and handed over to the manufacturer for repair.



In order to minimize the risk of malfunction and associated risks to staff, the device is not to be installed or used in particularly unfavorable conditions, where the following hazards occur:

- possible mechanical impacts, excessive shocks and vibration;
- excessive temperature fluctuation;
- water vapor condensation, dusting, icing.

Changes made to the manufacturing of products may be introduced before the paper version of the manual is updated. The up-to-date manuals are available on the manufacturer's website: www.aplisens.com.

TABLE OF CONTENTS

1. INTRODUCTION	9
1.1. Purpose of the document	9
2. SAFETY	9
3. TRANSPORT AND STORAGE	10
3.1. Delivery check.....	10
3.2. Transport.....	10
3.3. Storage	10
4. GUARANTEE	10
5. IDENTIFICATION	11
5.1. Manufacturer's address	11
5.2. Transmitter identification	11
5.3. CE mark, declaration of conformity.....	11
6. INSTALLATION	12
6.1. General recommendations	12
6.1.1. Installation instructions for transmitters with distance separators	12
7. ELECTRICAL CONNECTION	13
7.1. Cable connection to transmitter internal terminals	13
7.1.1. Connection of transmitters with PKD, PZ, SG, PM12 type connector (cable connection) ...	14
7.2. Power supply.....	14
7.2.1. Transmitter supply voltage	14
7.2.2. Resistance load in power supply line	14
7.2.3. Specifications of electrical switching terminals	15
7.3. Equipotential bonding.....	15
7.4. Overvoltage protection	15
7.5. Final inspection of cabling	15
8. OPERATION	15
8.1. Physical layer for RS485 data transfer	15
8.1.1. Introduction	15
8.1.2. Description.....	15
8.1.3. Details of RS485 "half-duplex"	16
8.1.3.1. Limited digital signal incremental rate	16
8.1.3.2. "Fail safe" mode.....	16
8.1.3.3. 1/16 of bus load	16
8.1.3.4. Line transmission.....	16
8.1.3.5. Polarizing resistors	17
8.1.3.6. Common mode voltage on RS485 bus	17
8.2. Data link layer	17
8.2.1. Modbus RTU serial transmission mode.....	18
8.2.2. Modbus RTU message format	18
8.2.3. Modbus RTU message transfer rules.....	19
8.2.3.1. Primary rules	19
8.2.3.2. Error handling	20
8.3. Application layer, description of implemented functions.....	20
8.3.1. System functions.....	20
8.3.1.1. 0x03 (3) "Read Holding Register"	20
8.3.1.2. 0x2B (43) "Read Device Identification"	20
8.3.2. Manufacturer/user functions.....	20
8.3.2.1. 0x64 (100) „Read coefficients”	20
8.3.2.2. 0x65 (101) „Write coefficients”	23
8.3.2.3. 0x66 (102) „Set Modbus Device Address (FLASH)”	23
8.3.2.4. 0x67 (103) „Set Speed, Parity, Stop”	23
8.3.2.5. 0x68 (104) „Perform Action”.....	24
8.3.2.6. 0x69 (105) „Set Modbus Device Address (RAM)”	24

8.3.3. Modbus register layout	25
8.3.3.1. Request message with the function 0x03 (Example 1)	26
8.3.3.2. Request message (Example 2)	26
8.3.3.3. Received data based on example 2, assigned to the relevant registers.....	27
8.3.4. Data from registers readable using function 03.....	27
8.3.4.1. Register 1, user value, % control of the set range	27
8.3.4.2. Register 3, pressure of sensor 1	28
8.3.4.3. Register 5, pressure of sensor 2	28
8.3.4.4. Register 7, temperature of sensor 1	28
8.3.4.5. Register 9, CPU temperature	28
8.3.4.6. Register 11, temperature of sensor 2	28
8.3.4.7. Register 13, standby	28
8.3.4.8. Register 15, standby	28
8.3.4.9. Register 17, user value	29
8.3.4.10. Register 18, pressure of sensor 1 – binary format, integer and sign	29
8.3.4.11. Register 19, pressure of sensor 2.....	29
8.3.4.12. Register 20, temperature of sensor 2 – binary format, integer and sign.....	29
8.3.4.13. Register 21, CPU temperature – binary format, integer and sign.....	29
8.3.4.14. Register 22, temperature of sensor 2	29
8.3.4.15. Register 23, pressure unit	30
8.3.4.16. Register 24, standby	30
8.3.4.17. Register 25, standby	30
8.3.4.18. Register 27, standby	30
8.3.4.19. Register 29, standby	30
8.3.4.20. Register 31, response delay value	30
8.3.4.21. Register 32, Modbus address.....	31
8.3.4.22. Register 33, identity register.....	31
8.3.4.23. Register 36, status register.....	31
8.4. Configuration mode	31
8.4.1. “Modbus Configurator” software. Serial port configuration, Modbus network scanning, single transmitter search	31
8.4.2. Transmitter identification data.....	34
8.4.3. Reading the transmitter’s limit values process variables	35
8.4.4. Reading alphanumeric identification data	36
8.4.5. Damping and transfer function.....	36
8.4.6. Modbus mode.....	36
8.4.7. Restore default settings	37
8.4.8. Write lock	37
8.4.9. Additional operation.....	37
8.4.10. Calibrations	37
8.4.10.1. Pressure or differential pressure calibration.	38
8.4.10.2. Calibrating the analogue output.....	38
8.4.10.3. Setting the fixed current mode.....	38
8.4.10.4. Configuration write	38
8.5. Current loop 4-20 mA operation (applies to PCE-28.Modbus and PRE-28. Modbus) or with an internal 4-20 mA current controller (applies to PCE-28.Modbus-ALW)	39
8.5.1. Set range.....	39
8.5.2. Alarm signal levels.....	40
8.6. Modbus mode	41
8.7. Operating the LCD display (applies to PCE-28.Modbus-ALW).....	41
8.7.1. Local LCD display.....	41
8.7.2. Display configuration	42
8.7.3. Local Menu, error messages	43
8.7.4. Basic technical parameter display	43
9. MAINTENANCE	44
9.1. Periodic inspections	44

9.2. Non-periodic inspections	44
9.3. Cleaning/washing	44
9.4. Diaphragm cleaning	44
9.5. Spare parts.....	44
9.6. Repair	44
9.7. Returns	44
10. SCRAPPING, DISPOSAL	45
11. HISTORY OF REVISIONS	45
11.1. PCB and software versions	45
Appendix 1. Explosion-proof device manual EN.IX.PCE.PRE.28.MODBUS.....	47

LIST OF DRAWINGS

Figure 1. Diagram of connecting the transmitters in the Modbus network.....	13
Figure 2 Example of Modbus network configuration	16
Figure 3 Set range and measurement limits	39
Figure 4 LCD Display	41
Figure 5 Structure of the local setpoints MENU	42

LIST OF TABLES

Table 1 Symbols occurring on the transmitter nameplate	11
Table 2 Connection, output signals.....	14
Table 3 Permissible transmitter supply voltages	14
Table 4 Set range and measurement limits.....	40

1. INTRODUCTION

1.1. Purpose of the document

The subject of manual are pressure transmitters **PCE-28.Modbus**, differential pressure transmitters **PRE-28.Modbus** in standard, intrinsically safe Exi, flameproof Exd versions and **PCE-28.Modbus16**, **PRE-28.Modbus16** in intrinsically safe Exi version, hereinafter referred jointly to as the transmitters.

The manual contains data, tips and general recommendations for safe installation and operation of the transmitters, as well as troubleshooting in case of possible failure.

The manual does not cover explosion protection issues.



It is forbidden to use devices in hazardous areas without appropriate permits.



Data on the transmitters **PCE-28.Modbus**, **PRE-28.Modbus** and **PCE-28.Modbus16**, **PRE-28.Modbus16** in intrinsically safe version according to ATEX are included in the **Explosion-proof device manual** marked as EN.IX.PCE.PRE.28.MODBUS.

Data on the transmitters **PCE-28.Modbus**, **PRE-28.Modbus** in flameproof version according to ATEX and IECEx are included in the pressure transmitters user manual marked as EN.IO.PCE.PRE.28.29.EXD.

2. SAFETY



- The installation and start-up of the device and any activities related to operation shall be carried out after thorough examination of the contents of user's manual and the instructions related thereto.
- Installation and maintenance should be carried out by qualified staff having the required authorizations to install electrical and measuring devices.
- The device shall be used according to its intended purpose in line with the permissible parameters specified on the nameplate (→ [Transmitter identification](#)).
- The protection elements used by the manufacturer to ensure transmitter safety may be less effective if the device is operated in a manner not consistent with its intended purpose.
- Before installing or disassembling the device, it is absolutely necessary to disconnect it from the power source.
- No repairs or alterations to the transmitter electronic system are permitted. Assessment of damages and possible repair may only be performed by the manufacturer or authorized representative.
- Do not use instruments if damaged. In case of malfunction, the device must be put out of operation.

3. TRANSPORT AND STORAGE

3.1. Delivery check

After receiving the delivery, please refer to the general terms and conditions of contracts available on the manufacturer website: https://aplisens.com/ogolne_warunki_umow.html.

3.2. Transport

Transport of transmitters shall be carried out with the use of covered means of transport, in original packages with diaphragm provided with protection. The packaging shall be protected against movement and direct impact of atmospheric factors.

3.3. Storage

Transmitters shall be stored in a factory packaging, in a room without vapors and aggressive substances, protected against mechanical impact.

Allowable range of storage temperature according to the data sheet



Operating temperature range and measured medium for transmitters in the Ex version included in the explosion-proof device manual marked as EN.IX.PCE.PRE.28.MOD-BUS.

4. GUARANTEE

General terms and conditions of guarantee are available on the manufacturer's website: www.aplisens.com/ogolne_warunki_gwarancji.



The guarantee shall be repealed if the device is used against its intended use, failure to comply with user's manual or interference with the structure of the device.

5. IDENTIFICATION







5.1. Manufacturer's address

APLISENS S.A.
03-192 Warsaw
Morelowa 7 St.
Poland

5.2. Transmitter identification

Depending on the version of the transmitter, the nameplates may differ in the amount of information and parameters.

Table 1 Symbols occurring on the transmitter nameplate

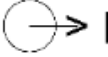
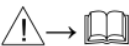
	Logo and name of manufacturer
	CE mark
	CE mark with the number of notified body
	QR code
TYPE:	Transmitter type
ID	Transmitter model ID
	Types of measurement input
 U	Supply voltage values
 T _{amb}	Permissible range of ambient temperature
 I	Output signal
El. connection:	Type of electrical connection
Ser.- No.	Transmitter serial number
Year of production	Year of production
IP	IP range value
//lower part of the nameplate//	Special execution
	Note about the read the manual
Aplisens S.A. ul. Morelowa 7, 03-192 Warszawa	Manufacturer address

5.3. CE mark, declaration of conformity

The device has been designed to meet the highest safety standards, has been tested and has left the factory in a condition that is safe for operation. The device complies with the applicable standards and regulations listed in the EU Declaration of Conformity and has CE marking on nameplate.

6. INSTALLATION

6.1. General recommendations



It is recommended that in case of a gaseous medium, the transmitters should be installed above the measuring point so that condensate may flow to the point from which the measured pressure is collected, while in case of liquid medium or steam, it should be installed below the point of pressure intake.

For low measurement ranges, there may be an influence of transmitter's position and influence of impulse lines position and liquid filling method on output signal. Any possible misalignment of the signal should be corrected by resetting the transmitters after mounting.

6.1.1. Installation instructions for transmitters with distance separators

The protection of the separator diaphragm can only be removed shortly before installation. Hydrostatic pressure of the manometric liquid column in the transmitter-separator system may cause incorrect indication of the measured value. After installation, the transmitter must be pressure-reset.

Do not clean or touch separator diaphragms using hard or pointy objects.

Separators with pressure transmitter form a closed, calibrated system filled with gauge fluid. The opening for filling the device with gauge fluid is sealed and must not be opened.



When choosing a mounting location, it is necessary to ensure sufficient stress relief of the capillaries tension in order to avoid excessive bending.

Incorrect installation of the sealing may result in incorrect measurement indications.

Special attention must be paid when selecting correct dimensions of the sealing.



As standard, the separators are not provided with the gaskets.

7. ELECTRICAL CONNECTION

7.1. Cable connection to transmitter internal terminals



All connection and installation operations shall be performed with disconnected supply voltage and other external voltages, if used.



Failure to provide proper connection of the transmitter may result in danger. Risk of electric shock and/or ignition in potentially explosive atmospheres.

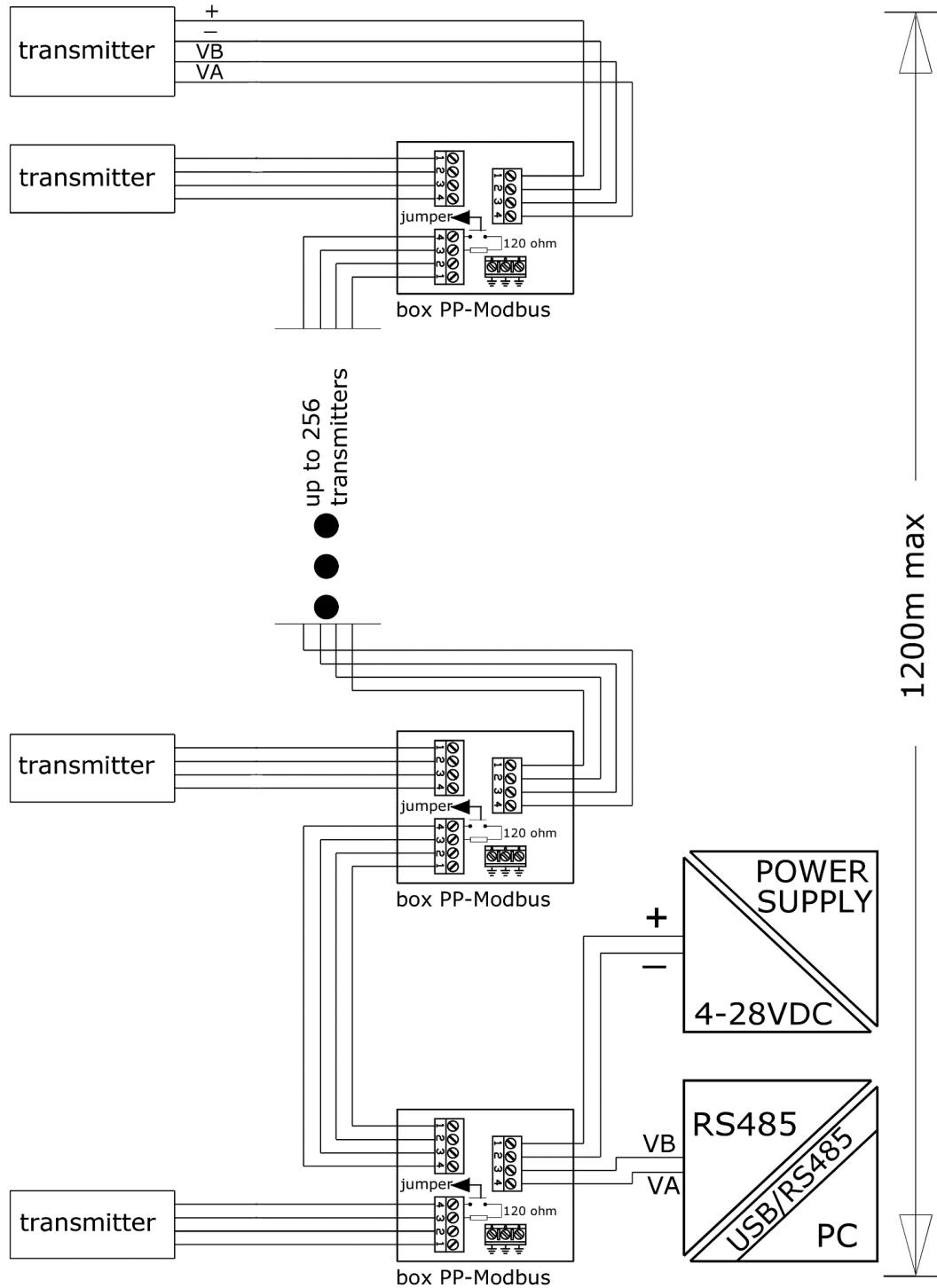

Figure 1. Diagram of connecting the transmitters in the Modbus network

7.1.1. Connection of transmitters with PKD, PZ, SG, PM12 type connector (cable connection)

Electrical connections of transmitters equipped with PKD, SG, PM12 type connectors are made through a terminal box with a gland in which the converter cable connects to the further part of the signal line. The junction box should have a "breathing" hole that equalizes the pressure inside the box to the atmospheric pressure.

Table 2 Connection, output signals

Function	Output of signals		
	Electrical connection		
	PM12 (Connector connection)	PKD,SG (Cable connection)	PZ (Connector connection)
SHIELDED CABLE	1	Green	-
+	2	Red	1
-(GND)	3	Black	2
RS-485 A +	4	Blue	4
RS-485 B -	5	Yellow	3

7.2. Power supply

7.2.1. Transmitter supply voltage



Power cables may be live.
There is a risk of electric shock and/or explosion.



Installation of the transmitter in explosion-risk atmospheres must comply with national standards and regulations.

Table 3 Permissible transmitter supply voltages

Mode / version	Minimum supply voltage	Maximum supply voltage
Modbus mode standard version	4 V DC	28 V DC
Analog mode standard version	5 V DC	28 V DC
Modbus Exi version for PCE-28.Modbus and PRE-28.Modbus	4 V DC	10 V DC
Modbus Exi version for PCE-28.Modbus16 and PRE-28.Modbus16	10.5 V DC	15.8 V DC

- current for Modbus mode < 3,6 mA for PCE-28.Modbus and PRE-28.Modbus;
- current for Modbus mode < 23 mA for PCE-28.Modbus16 and PRE-28.Modbus16.
- current for Modbus mode < 24 mA for PCE-28.Modbus-ALW.

7.2.2. Resistance load in power supply line

The power line resistance, power source resistance and other additional serial resistances increase the voltage drops between the power source and the transmitter. The maximum current is 0,022 A. The maximum resistance value in the power circuit (along with the power cables resistance) is defined by the formula:

$$R_{Lmax} = \frac{(U_{zas} - U_{min})}{0,022 A}$$

where:

U_{zas} – voltage at the supply terminals of 4...20 mA current loop [V],

U_{min} – minimum supply voltage of transmitter → [Table 3 Permissible transmitter supply voltages](#),

R_{L_MAX} – maximum power supply line resistance [Ω].

7.2.3. Specifications of electrical switching terminals

Internal electrical switching terminals are suitable for conductors with the cross-section from 0,5 to 2,5 mm².

7.3. Equipotential bonding

In the case of using a cable in the screen, connect the screen on one side at the transmitter's power supply point.

The transmitter in intrinsically version should be powered from a galvanically separated power source or, if this is not possible, equipotential bonding of the transmitter and the power supply device should be ensured by means of equipotential bonding conductors. In this respect the locally applicable regulations must be observed.

7.4. Overvoltage protection

Transmitters may be exposed to the effect of switching overvoltage's or those resulting from lightning discharges. Protection against overvoltage's between the wires of the transmission line is provided by TVS diodes installed in all types of transmitters. In order to protect against overvoltage's between the transmission line and the ground or housing (which are not protected by diodes connected between the line wires), additional protection is applied in the form of gas surge arresters. Additionally, an external protective device can be used, e.g. the UZ-2 system by APLISENS or others.

7.5. Final inspection of cabling

After completing the electrical installation of the transmitter it is necessary to check the following:

- that the supply voltage measured at the transmitter terminals at maximum set current match the range of supply voltage specified on the transmitter nameplate;
- that the transmitter is connected according to the information given in section ([→7.1 Cable connection to transmitter internal terminals](#));
- if all cable mount tightened (depending on the version);
- if the cable gland tightened (depending on the version).

8. OPERATION

8.1. Physical layer for RS485 data transfer

8.1.1. Introduction

The transmitter is connected to the system via RS485 serial interface. This interface guarantees high resistance to interferences and flexible bus structure, e.g. multiple "Slave" devices can be managed via a single "Master" device. An RS485 half-duplex mode has been implemented to reduce the number of necessary communication cables. This means that 2 communication cables are required.

8.1.2. Description

To ensure correct operation of multiple devices on one serial communication bus, appropriate leads (RS485A, RS485B, GND and +Vcc) should be connected in parallel to the bus. Before connecting to the bus, a unique address must be defined for each device.

A network of up to 1,200 meters with max 247 Modbus devices can be set up. Each cable junction from the bus can be up to 15 m long.

The cables should conform to EIA RS485.

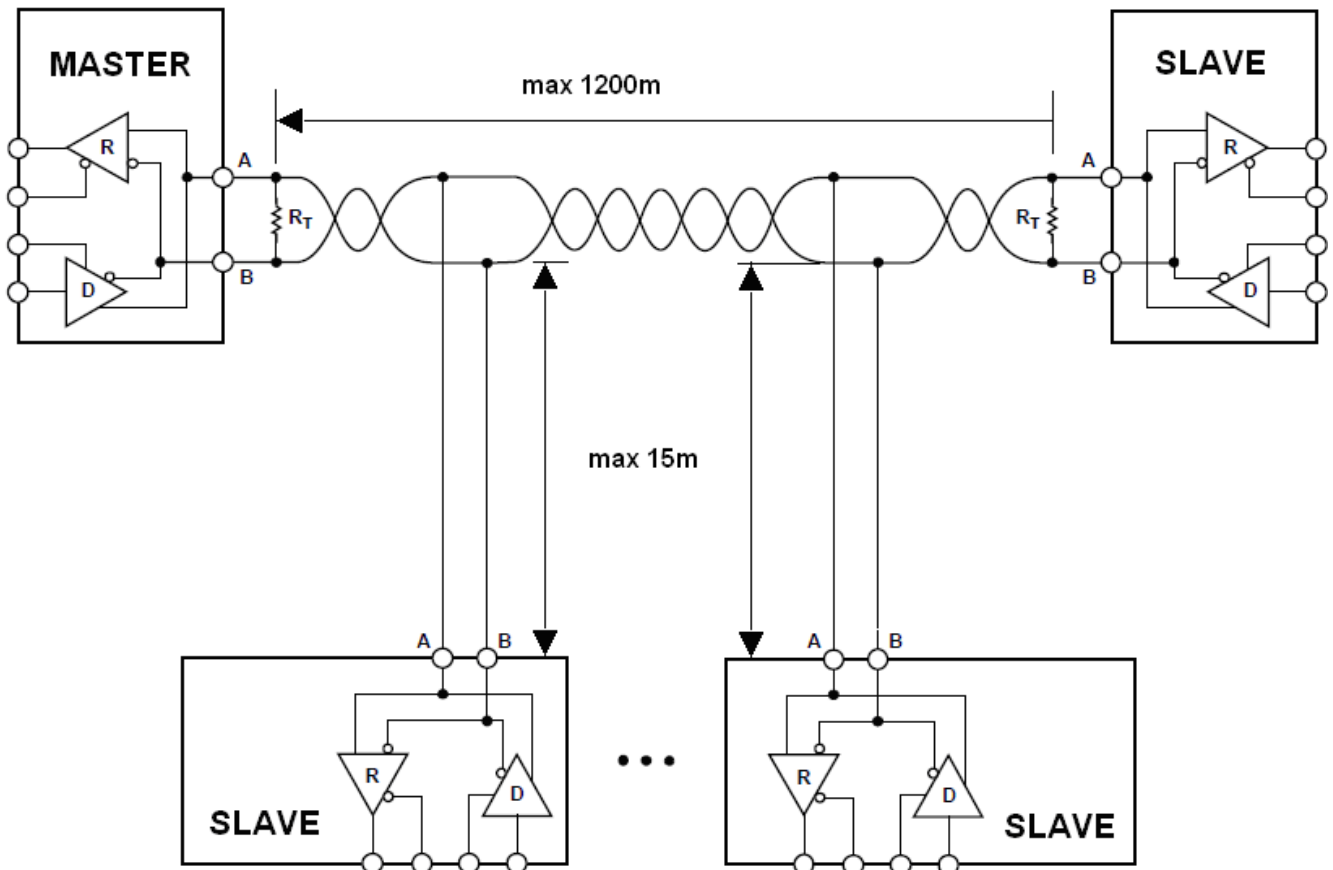

Figure 2 Example of Modbus network configuration

8.1.3. Details of RS485 “half-duplex”

To ensure the best possible efficiency in industrial environment, the transmitters from Aplisens S.A. are provided with RS485 transceivers with appropriately customized operating parameters. To provide compatibility and the best possible working conditions, the “Master” transceiver should conform to the specifications below.

8.1.3.1. Limited digital signal incremental rate

To eliminate oscillations and interferences, the output voltage slew rate of the signals from the transmitters is limited by the use of appropriate RS485 transceivers. This makes it possible to use standard cable-based connections and/or customized topologies (e.g. branches up to 15 m long).

8.1.3.2. “Fail safe” mode

The “fail-safe” mode means a strictly defined level of received signals – both in open bus connection and **closed bus** connection modes. It is very important in half-duplex mode when all the devices connected to the bus are in receiving mode. This approach eliminates the need to use external polarization resistors. Power losses in RS485 transceivers caused by e.g. bus short-circuit, are limited by the use of thermal safety features in transmitting and receiving circuits.

8.1.3.3. 1/16 of bus load

Input impedance in RS485 transceivers used in the transmitters from Aplisens S.A., in receiving mode, is higher than the standard impedance to enable connecting up to 256 devices to the bus.

8.1.3.4. Line transmission

The terminating resistors on the RS485 bus should be connected between the points A and B at the beginning and at the end of the communication bus. When working with long transmission lines at the highest transfer rates, resistor value should correspond to cable impedance which typically is 120 Ω . With shorter bus segments and lower transfer rates, resistor with higher values, e.g. 1 k Ω , can be used to reduce current fluctuations in the transmission line (with 2 resistors of 120 Ω , the amplitude can be as high as ca 50 mA). At least one resistor should be used to ensure stable communication.

If a “fail-safe” device is connected to the “Master” bus, the electromagnetic environment in which the communication bus is located is free of interferences and the transmission line is relatively short (several meters) and terminations resistors are not required.

The Aplisens S.A. devices described in this document are NOT provided with terminations resistors.

8.1.3.5. Polarizing resistors

Polarizing resistors can be used for ensuring permanently defined voltage levels in relation to power supply on the communication bus. The resistors are connected respectively:

- between point A on the bus and +Vcc point;
- between point B on the bus and GND point.

They are necessary if any of the transceivers of the devices connected to the bus is not a fail-safe transceiver. The resistance of such resistors depends on the power supply connected to the bus, input current in the connected devices operated in receiving mode, and it should be calculated or determined experimentally. It usually ranges from 450 to 650 Ω. If the “Master” device is in fail-safe mode and only works with Modbus transmitters from Aplisens S.A. polarizing resistors are not required.

The APLISENS S.A. devices described in this document are NOT integrated with polarizing resistors.

8.1.3.6. Common mode voltage on RS485 bus

The transmitters do not have galvanic isolation so the common voltage level should be equalized to the common potential by connecting the negative poles of the power supply of the transmitters together (e.g. GND).

Transmission line definitions:

Signal	Designation by APLISENS and transceiver manufacturers	Designation acc. to EIA
Inverted (-)	B	A
Simple (+)	A	B

8.2. Data link layer

This subsection describes data transfer on the bus. Data and their control structures are divided into groups and make up a message. A message means the smallest communication unit and only such units can be transferred between devices. “Half-duplex” mode means that at a given point in time only one device can be in transmitting mode while the other devices must be in receiving mode. A PC or a controller is a “Master” device and the connected measuring or execution devices are “Slave” devices. Messages are transferred at all times under the control of the “Master” device. All messages contain a “Slave” address. As a result two options of data transfer are available:

- **Broadcast mode**

This communication mode of the “Master” allows the “Slave” devices to receive and perform functions simultaneously, regardless of the “Slave” network address. In the APLISENS transmitters covered by this manual, the broadcast mode is used to make entries to the transmitters using the 101, 102, 103, 104, 105 functions. In the broadcast mode, the transmitters does not send back a telegram to acknowledge its receipt and that the function has been completed.

- **Unicast data transfer mode**

This mode enables communication between the “Master” device and a selected “Slave” device. The communication process involves sending a request message from the “Master” device and a response message from an appropriate “Slave” device. Only the “Master” device can send request messages. The request is received by all “Slave” devices connected to the bus, however, only a device with an address specified in the message sends a response. A “Slave” device must respond to a correctly received request message within the defined maximum time interval, otherwise the “Master” device recognizes that the request failed and will retry sending the message in accordance with the programmed algorithm.

8.2.1. Modbus RTU serial transmission mode

Data in the RS485 bus are transmitted serially. As described in the Modbus RTU standard (Modbus over Serial Line Specification and Implementation Guide v1.02), the following formats can be used:

- 1 start bit
- 8 data bits (binary coding, least significant is bit sent first)
- bits for parity checking:
 - 1 bit Even (default), or
 - 1 bit Odd, or
 - 0 bits None (no bits for parity control)
- 1 stop bit for Even or Odd parity mode, or
- 2 stop bits for None parity mode

Characters are always sent using 11 bits. The number of stop bits (1 or 2) is selected by the transmitter depending on whether an Even, Odd or None parity mode is set.

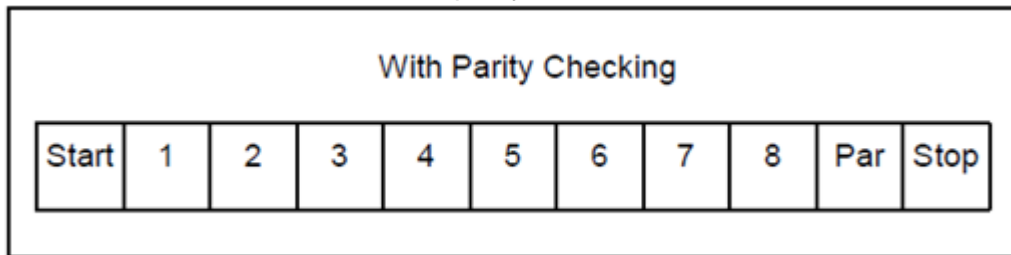

Bit sequence with parity checking.

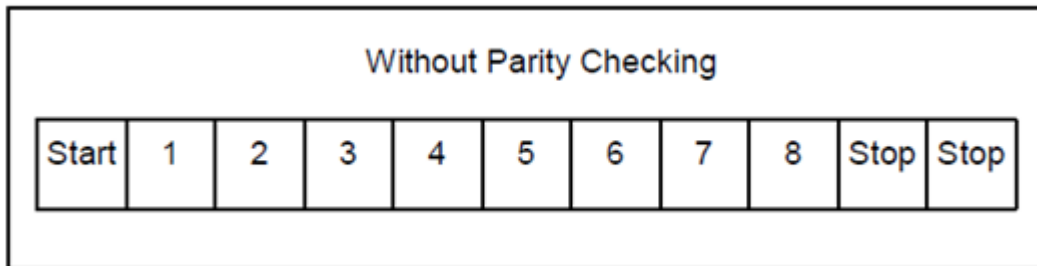

Bit sequence without parity checking.

8.2.2. Modbus RTU message format

All Modbus RTU messages are sent in the following format:

Slave Address	Function Code	Data	CRC
1 byte	1 byte	0 up to 252 byte(s)	2 bytes CRC Low, CRC Hi

Slave Address – network address of the “Slave” device. The address 0 is reserved for the broadcast in the query mode of the “Master” device. “Slave” devices, irrespective of their network address, should be able to perform the function of a write operation without sending back a response telegram in this mode.

The individual “Slave” devices are assigned addresses in the range of 1 – 247. In one network cannot be more than one device with the same address in this range. Addresses in the range 248...255 are reserved for future use.

0	From 1 to 247	From 248 to 255
Broadcast address	Slave individual addresses	Reserved

Function Code – A code to tell the “Slave” to which a request is addressed what functions are to be performed. Function codes use 7 bits (0...127). The oldest 8th bit is always zero when a message is sent by the “Master”. The same function code is returned in this field in the “Slave” response message. If the oldest 8th bit is zero, it means that the function was performed correctly and the data

returned in the message are also correct. If the oldest 8th bit is one, it means that a function error or a device error was detected.

Data – The “Function Code” can be followed by the field ‘Data’ containing control data (“Master” request) or read data (“Slave” response), depending on the function number. This field can contain up to 252 bytes of data. If the oldest 8th bit of the “Function code” in the “Slave” response is one, the data read are not entered in the field “Data” in the response message, but one byte of the field is used for sending an error code.

CRC – At the end of a message, there is always a field for the 2-byte control sum CRC16 sent according to the sequence “CRC Low | CRC High”. The control sum is calculated as defined in Supplement B to “Modbus over Serial Line Specification and Implementation Guide v1.02” available at <http://www.modbus.org/>.

8.2.3. Modbus RTU message transfer rules

8.2.3.1. Primary rules

- An address in the range 1...247 can only be assigned to one “Slave” device connected to the bus. If more devices connected to the bus are assigned the same address, they will send a response telegram, causing a conflict on the bus.
- Data transfer operations via messages are initiated at all times by the “Master”. This means that “Slave” devices can only send data-containing messages after receiving a properly addressed request message from the “Master”.
- A message is made up of a number of bytes. These bytes should be sent without any in-between intervals.

The maximum permissible silent interval between two successive characters must not exceed 1.5T, where T is the time it takes to transmit one character (11 bits). If the silent interval between two successive characters exceeds 1.5T, the message can be considered invalid and rejected by the device.

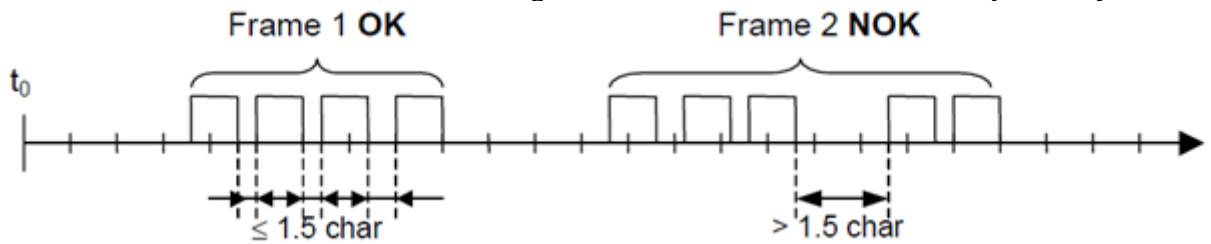

- The addressed “Slave” must respond within a defined silent interval, otherwise the response message will be considered invalid and rejected by the “Master”.

The silent interval between the request message sent by the “Master” and the response message sent by the “Slave” must not be shorter than 3.5T, where T is the time it takes to transmit one character (11 bits). The maximum silent interval after which a “Slave” device responds to the “Master” request message depends on the function code in the request and the data load. The response time in the APLISENS S.A. transmitters described in this document should be less than 5 ms, including the most disadvantageous conditions (data load, transfer rate).

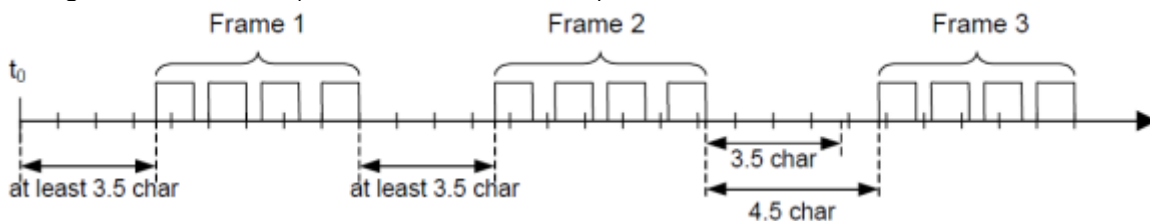

MODBUS message					
Start	Address	Function	Data	CRC Check	End
≥ 3.5 char	8 bits	8 bits	N x 8 bits	16 bits	≥ 3.5 char

8.2.3.2. Error handling

When messages are transferred between “Master” and “Slave” devices, two main types of errors may arise: transmission errors and “Slave” device errors.

Transmission errors, causes:

- The message received is too short due to e.g. an excessively long interval between bytes contained in the message.
- The message received is longer than allowed by the device’s reception buffer due to e.g. message frame syntax improperly programmed in the controller.
- The maximum character transmission time is exceeded due to an inappropriate transfer rate.
- The control sum calculated based on the message received does not correspond to the value sent in the message in the CRC field.

“Slave” devices do not respond to messages for which a transmission error is detected, the “Master” device can retry sending a request message if an invalid message receipt is detected. The respective algorithm is programmed in the “Master” device.

- Illegal function code.
- Illegal data address.
- Illegal data load.

Errors in functioning of the slave device, causes:

- Damage to the ADC transmitter, damage to the pressure sensor.
- Damage to the local oscillator of the microcontroller.
- Damage to RAM, FLASH, EEPROM.

Error codes conform to “Modbus over Serial Line Specification and Implementation Guide v1.02”.

8.3. Application layer, description of implemented functions

8.3.1. System functions

8.3.1.1. 0x03 (3) “Read Holding Register”

This function used to read the continuous address space of a data block. The master sets the log start address (2 bytes) and the number of 2-byte read logs. The logs are addressed starting from zero, for this reason, e.g. the log 1 has an address 0x0000, the log 3 has an address 0x0004, log 17 has an address 0x0020, i.e. 32.

The data read from each log is transmitted by the slave as 2 bytes per log, where the first byte in the sequence is a byte older than the next one. When reading data from more than one log, the data from the slave is transmitted according to the log numbering.

The logs contain data related to process variable measurements, temperatures as well as other transmitter settings.

8.3.1.2. 0x2B (43) “Read Device Identification”

Function used to read, in streaming mode, the basic transmitter identification data, including the manufacturer name, product code, software revision.

Read Device Identification | 7 bytes request, 46 bytes response |

Req: [ADD][FC][0x0E][0x01][0x00][CRC_H][CRC_L]

Resp: according to **Modbus Application Protocol Specification V1.1**

8.3.2. Manufacturer/user functions

8.3.2.1. 0x64 (100) „Read coefficients”

Function used to read 4 bytes of coefficients.

Read Coefficients | 5 bytes request, 9 bytes response |

Req: [ADD][FC][COEFF_NUMBER][CRC_H][CRC_L]

Resp: [ADD][FC][COEFF_NUMBER][DATA0] [DATA1] [DATA2] [DATA3] [CRC_H][CRC_L]

COEFFICIENT NUMBER	NAME	DESCRIPTION OF DATA0 ... DATA3
0x00	Dumping Time "s"	float IEE754 referred to PVU - Primary Variable Unit
0x01	Upper sensor limit	float IEE754 referred to PVU - Primary Variable Unit
0x02	Lower sensor limit	float IEE754 referred to PVU - Primary Variable Unit
0x03	Minimum span	float IEE754 referred to PVU - Primary Variable Unit
0x04	Upper range value	float IEE754 referred to PVU - Primary Variable Unit
0x05	Lower range value	float IEE754 referred to PVU - Primary Variable Unit
0x06	Max work temperature	float IEE754 referred to °C
0x07	Min work temperature	float IEE754 referred to °C
0x80	Auxiliary Coefficients_0	<p>[FIR] [ALM] [TRF] [PVU]</p> <p>[FIR] – ADC integration time Filter Register</p> <p>0x00 18,6 ms</p> <p>0x01 22,0 ms</p> <p>0x02 62,0 ms</p> <p>0x03 102,0 ms</p> <p>0x04 122,4 ms</p> <p>0x05 121,7 ms</p> <p>0x06 152,4 ms</p> <p>0x07 212,6 ms</p> <p>[ALM] – Alarm Mode (current output)</p> <p>BIT0 0 = no alarm, 1 = alarm on ADC converter failures</p> <p>BIT1 0 = no alarm, 1 = alarm on pressure sensor failures</p> <p>BIT2 0 = no alarm, 1 = alarm on memory failures</p> <p>BIT3 0 = no alarm, 1 = alarm on oscillator failures</p> <p>BIT6 0 = Alarm 22,0 mA, 1=Alarm 3,6 mA</p> <p>BIT7 0 = 3,9 ... 20,5 mA operation</p> <p>1 = 3,8 ... 20,5 mA operation</p> <p>[TRF] - Transfer Function Code</p> <p>0x00 Linear (y=x)</p> <p>0x01 Square root (y=x^{1/2})</p> <p>0x04 Special (piecewise linear)</p> <p>0x05 Square (y=x²)</p> <p>[PVU] - Primary Variable Unit</p> <p>0x01 InH2O inches of water at 68 °F / 20 °C</p> <p>0x02 InHg inches of mercury at 0 °C</p> <p>0x03 FtH2O feet of water at 68 °F / 20 °C</p> <p>0x04 mmH2O millimeters of water at 68 °F / 20 °C</p> <p>0x05 mmHg millimeters of mercury at 0 °C</p> <p>0x06 psi pounds per square inch</p> <p>0x07 bar bars</p> <p>0x08 mbar millibars</p> <p>0x09 g/cm² grams per square centimeter</p> <p>0x0A kg/cm² kilograms per square centimeter</p> <p>0x0B Pa pascals</p> <p>0x0C kPa kilopascals</p> <p>0x0D Torr torr</p> <p>0x0E ATM atmospheres</p> <p>0xAB mH2O4 °C meters of water at 4 °C</p> <p>0xED MPa megapascals</p> <p>0xEE inH2O4 °C inches of water at 4 °C</p> <p>0xEF mmH2O4 °C millimeters of water at 4 °C</p>
0x81	Auxiliary Coefficients_1	<p>[ADD][RS_mode_1][RS_mode_2][RS_mode_3]</p> <p>[ADD] Modbus Address</p> <p>[RS_mode_1]</p> <p>BIT0 - 9600 bps</p> <p>BIT1 - 19200 bps</p> <p>BIT2 - 28800 bps</p> <p>BIT3 - 38400 bps</p> <p>BIT4 - 57600 bps</p>

COEFFICIENT NUMBER	NAME	DESCRIPTION OF DATA0 ... DATA3
		BIT5 - 115200 bps BIT6 - n.u. BIT7 - n.u. [RS_mode_2] BIT0 - n.u. BIT2,BIT1 - 01 - NONE, 2STOP BIT2,BIT1 - 10 - ODD, 1STOP BIT2,BIT1 - 00 - EVEN, 1STOP BIT3 - n.u. BIT4 - n.u. BIT5 - 1200 bps0 BIT6 - 2400 bps BIT7 - 4800 bps [RS_mode_3] n.u. Remarks: Only one bit from BIT0 to BIT5 in RS_mode_1 and bits from BIT5 to BIT7 in RS_mode_2 can be in "ON" state. [n.u.] Bit not used (can be set as zero – "OFF" state)
0x82	Auxiliary Coefficients_2	[-][-][-][WP] [-][-][-] Not used, data negligible [WP] 0x00 Not write protected 0x01 Write protected
0x83	Auxiliary Coefficients_3	[-][-][-][-] Not used, data negligible
0x88	Auxiliary Coefficients_4	[SLDC_1_H][SLDC_1_L][SLDC2_H][SLDC_2_L] [SLDC_1_H] Most significant byte of Bus Communication Error Counter [SLDC_1_L] Least significant byte of Bus Communication Error Counter [SLDC_2_H] Most significant byte of Slave Exception Error Counter [SLDC_2_L] Least significant byte of Slave Exception Error Counter
0x89	Auxiliary Coefficients_5	[SLDC_3_H][SLDC_3_L][SLDC_4_H][SLDC_4_L] [SLDC_3_H] Most significant byte of Broadcast RX Mode Counter [SLDC_3_L] Least significant byte of Broadcast RX Mode Counter [SLDC_4_H] Most significant byte of CRC RX Error Counter [SLDC_4_L] Least significant byte of CRC RX Error Counter
Legend: FIR Filter Register ALM Alarm Mode Code TRF Transfer Function Code PVU Primary Variable Unit WP Write Protection RS_mode_1 Communication settings 1 RS_mode_2 Communication settings 2 RS_mode_3 Communication settings 3 SLDC_1_H,L Bus Communication Error Counter, a 16-bit binary counter, reset after overflow or POR SLDC_2_H,L Slave Exception Error Counter, a 16-bit binary counter, reset after overflow or POR SLDC_3_H,L Broadcast RX Mode Counter, a 16-bit binary counter, reset after overflow or POR		

8.3.2.2. 0x65 (101) „Write coefficients”

Function used to store 4 bytes of coefficients.

Write Coefficients | 9 bytes request, 9 bytes response |

Req: [ADD][FC][COEFF_NUMBER][DATA0][DATA1][DATA2][DATA3][CRC_H][CRC_L]

Resp: [ADD][FC][COEFF_NUMBER][DATA0][DATA1][DATA2][DATA3][CRC_H][CRC_L]

COEFFICIENT NUMBER	NAME	DESCRIPTION OF DATA0 ... DATA3
0x00	Dumping Time "s"	float IEE754
0x80	Auxiliary Coefficients_0	4 bytes [-][-][-][PVU]
Remarks: Unicast / Broadcast mode available, no response with Broadcast Mode.		
Legend: PVU Primary Variable Unit [-] Data in byte negligible, not currently used		

8.3.2.3. 0x66 (102) „Set Modbus Device Address (FLASH)”

Function used to store the Modbus address in non-volatile FLASH memory.

Caution! Using the broadcast mode for this function, for more than one device connected in the network, will set them to the same address and block further communication.

Set Modbus Device Address (FLASH) | 5 bytes request, 5 bytes response |

Req: [ADD][FC][new_ADD][CRC_H][CRC_L]

Resp: [ADD][FC][old_ADD][CRC_H][CRC_L]

COEFFICIENT NAME	DESCRIPTION
new_ADD	New Modbus device address from the range 1...127 to be store in the FLASH memory.
old_ADD	Previous Modbus device address.
Remarks: Unicast / Broadcast mode available, no response with Broadcast Mode. Automatically performs a HOT RE-SET after execution.	

8.3.2.4. 0x67 (103) „Set Speed, Parity, Stop”

Function used to configure the 3 coefficients that define the Modbus communication parameters.

Set Speed, Parity, Stop | 7 bytes request, 7 bytes response |

Req: [ADD][FC][RS_mode_1][RS_mode_2][RS_mode_3][CRC_H][CRC_L]

Resp: [ADD][FC][RS_mode_1][RS_mode_2][RS_mode_3][CRC_H][CRC_L]

COEFFICIENT NAME	DESCRIPTION OF COEFFICIENTS
RS_mode_1	[RS_mode_1] BIT0 - 9600 bps BIT1 - 19200 bps BIT2 - 28800 bps BIT3 - 38400 bps BIT4 - 57600 bps BIT5 - 115200 bps BIT6 - n.u. BIT7 - n.u.
RS_mode_2	[RS_mode_2] BIT0 - n.u. BIT2,BIT1 - 01 - NONE, 2STOP BIT2,BIT1 - 10 - ODD, 1STOP BIT2,BIT1 - 00 - EVEN, 1STOP BIT3 - n.u. BIT4 - n.u. BIT5 - 1200 bps0 BIT6 - 2400 bps BIT7 - 4800 bps

RS_mode_3	[RS_mode_3] Data in byte negligible, currently not used for configuration
Remarks: Unicast / Broadcast mode available, no response in broadcast mode. Only one bit from BIT0 to BIT5 in RS_mode_1 and bits from BIT5 to BIT7 in RS_mode_2 can be in "ON" state. [n.u.] Bit not used (can be set as zero – "OFF" state)	

8.3.2.5. 0x68 (104) „Perform Action”

Function used to perform specific transmitter actions.

Req: [ADD][FC][DATA][CRC_H][CRC_L]

Resp: [ADD][FC][DATA][CRC_H][CRC_L]

COEFFICIENT NAME	DESCRIPTION OF ACTION
DATA	[DATA] 0x00 – Zeroing Pressure 0xFD - Set Write Protection 0xFE - Remove Write Protection 0xFF - Hot Reset
Remarks: Unicast / Broadcast mode available, no response in broadcast mode. The reset function 0xFF may take about 2 seconds to complete.	

8.3.2.6. 0x69 (105) „Set Modbus Device Address (RAM)”

Function used to store the Modbus address in volatile RAM.

0x69 | 105 | Set Modbus Device Address (RAM) | 5 bytes request, 5 bytes response |

Req: [ADD][FC][new_ADD][CRC_H][CRC_L]

Resp: [ADD][FC][old_ADD][CRC_H][CRC_L]

COEFFICIENT NAME	DESCRIPTION
new_ADD	New device address from the range 1...127 to be store in the RAM memory.
old_ADD	Previous device address.
Remarks: Unicast / Broadcast mode available, no response in broadcast mode. The new device address is valid until POWER ON RESET or HOT RESET, after their execution it returns to the address saved in the FLASH memory.	

8.3.3. Modbus register layout

Register	Address (hex)	Purpose	Notes	Format	Bytes (2 bytes per register)
1	0x0000	User specific	% of the controlled set range	IEEE754	4 bytes (2 registers)
3	0x0002	Pressure of sensor 1	Pressure or level process variable	IEEE754	4 bytes (2 registers)
5	0x0004	Pressure of sensor 2	Constant 0	IEEE754	4 bytes (2 registers)
7	0x0006	Temperature of sensor 1	Sensor 1 temperature process variable at °C	IEEE754	4 bytes (2 registers)
9	0x0008	CPU temperature	CPU temperature process variable at °C	IEEE754	4 bytes (2 registers)
11	0x000A	Temperature of sensor 2	Constant 0 °C	IEEE754	4 bytes (2 registers)
13	0x000C	-----	-----	-----	4 bytes (2 registers)
15	0x000E	-----	-----	-----	4 bytes (2 registers)
17	0x0010	User specific	1/100% of the controlled set range	Signed 16-bit int	2 bytes (1 register)
18	0x0011	Pressure of sensor 1	Integer, 1/100 of the pressure or level unit	Signed 16-bit int	2 bytes (1 register)
19	0x0012	Pressure of sensor 2	Value 0 1/100 of the selected unit	Signed 16-bit int	2 bytes (1 register)
20	0x0013	Temperature of sensor 1	Integer, 1/100°C	Signed 16-bit int	2 bytes (1 register)
21	0x0014	CPU temperature	Integer, 1/100°C	Signed 16-bit int	2 bytes (1 register)
22	0x0015	Temperature of sensor 2	Value 0 1/100 at °C	Signed 16-bit int	2 bytes (1 register)
23	0x0016	Pressure unit	Pressure or level unit	Unsigned 16-bit int	2 bytes (1 register)
24	0x0017	-----	-----	-----	2 bytes (1 register)
25	0x0018	Upper sensor limit	Upper limit of the standard range	IEEE754	4 bytes (2 registers)
27	0x001A	Lower sensor limit	Lower limit of the standard range	IEEE754	4 bytes (2 registers)
29	0x001C	Damping value	Seconds (s)	IEEE754	4 bytes (2 registers)
31	0x001E	Response delay value	Milliseconds (ms)	Unsigned 16-bit int	2 bytes (1 register)
32	0x001F	Modbus address	1...247	Unsigned 8-bit int	2 bytes (1 register)
33	0x0020	Identity register		Unsigned 8-bit int	6 bytes (3 registers)
36	0x0023	Status register		8-bit flags	2 bytes (1 register)

* Fields shaded in gray are not active in the specified models .

8.3.3.1. Request message with the function 0x03 (Example 1)

Master request and slave response, sensor 1 pressure read value.

Request message							
Slave address	Function	Parameters				CRC(L)	CRC(H)
		Starting address in register (H)	Starting address in register (L)	Number of registers to be read (H)	Number of registers to be read (L)		
0x01	0x03	0x00	0x02	0x00	0x02	0x65	0xCB
Response message							
Slave address	Function	Parameters		CRC(L)	CRC(H)		
		Number of data bytes	Data value (sensor 1 pressure in IEEE754 format), hexadecimal numbers				
0x01	0x03	0x04	40 5F D1 BC		0x82	0x00	

8.3.3.2. Request message (Example 2)

Master request and slave response, read total accessible address space.

Request message							
Slave address	Function	Parameters				CRC(L)	CRC(H)
		Starting address in register (H)	Starting address in register (L)	Number of registers to be read (H)	Number of registers to be read (L)		
0x01	0x03	0x00	0x00	0x00	0x24	0x45	0xD1
Response message							
Slave address	Function	Parameters		CRC(L)	CRC(H)		
		Number of data bytes	Memory content in registers read, hexadecimal numbers				
0x01	0x03	0x48	00 00 00 00 40 5F F8 DD 00 00 00 00 41 C8 00 00 41 C8 00 00 00 00 00 00 00 00 00 00 00 00 00 00 00 00 01 5E 00 00 09 C4 09 C4 00 00 00 0C 00 00 42 C8 00 01 00 00 00 00 00 00 00 00 00 00 00 01 00 BC 7D 00 00 01 00 00		0x97	0xCE	

8.3.3.3. Received data based on example 2, assigned to the relevant registers.

1	0x0000	User specific	IEEE754	40 5F F8 DD	4 bytes (2 registers)
3	0x0002	Pressure of sensor 1	IEEE754	40 5F F8 DD	4 bytes (2 registers)
5	0x0004	Pressure of sensor 2	IEEE754	00 00 00 00	4 bytes (2 registers)
7	0x0006	Temperature of sensor 1	IEEE754	41 C8 00 00	4 bytes (2 registers)
9	0x0008	CPU temperature	IEEE754	41 C8 00 00	4 bytes (2 registers)
11	0x000A	Temperature of sensor 2	IEEE754	00 00 00 00	4 bytes (2 registers)
13	0x000C	-----	-----	00 00 00 00	4 bytes (2 registers)
15	0x000E	-----	-----	00 00 00 00	4 bytes (2 registers)
17	0x0010	User specific	Signed 16-bit int	01 5E	2 bytes (1 register)
18	0x0011	Pressure of sensor 1	Signed 16-bit int	01 5E	2 bytes (1 register)
19	0x0012	Pressure of sensor 2	Signed 16-bit int	00 00	2 bytes (1 register)
20	0x0013	Temperature of sensor 1	Signed 16-bit int	09 C4	2 bytes (1 register)
21	0x0014	CPU temperature	Signed 16-bit int	09 C4	2 bytes (1 register)
22	0x0015	Temperature of sensor 2	Signed 16-bit int	00 00	2 bytes (1 register)
23	0x0016	Pressure unit	Unsigned 16-bit int	00 0C	2 bytes (1 register)
24	0x0017	-----	-----	00 00	2 bytes (1 register)
25	0x0018	Upper sensor limit	IEEE754	42 C8 00 01	4 bytes (2 registers)
27	0x001A	Lower sensor limit	IEEE754	00 00 00 00	4 bytes (2 registers)
29	0x001C	Damping value	IEEE754	00 00 00 00	4 bytes (2 registers)
31	0x001E	Response delay value	Unsigned 16-bit int	00 06	2 bytes (1 register)
32	0x001F	Modbus address	Unsigned 8-bit int	00 01	2 bytes (1 register)
33	0x0020	Identity register	Unsigned 8-bit int	00 BC 7D 00 00 01	6 bytes (3 registers)
36	0x0023	Status register	8-bit flags	00 00	2 bytes (1 register)

* Fields shaded in gray are not active in the specified models

8.3.4. Data from registers readable using function 03

8.3.4.1. Register 1, user value, % control of the set range

1	0x0000	User specific	% of the controlled set range	IEEE754	4 bytes (2 registers)
---	--------	----------------------	-------------------------------	---------	-----------------------

This is the percentage control value of the set range. For example: if the set range is 0...100 kPa, and the currently read pressure value is 50 kPa, the control value is 50%. The advantage of the set range is that the user can define its span by setting the start and end values contained within the basic pressure range. You can then perform mathematical operations on a part of the measuring range or use that part of the measuring range to display your custom units/values. This value can be used to perform additional mathematical operations on it in the controller working with the transmitter. It can also be converted by the transmitter by means of a quadratic, cubic, root or linear multi-section function and read from the log in this form using the **0x03 (3) Read Holding Register** function. This can be used, for example, to measure the flow on Venturi tubes or to calculate volumes in tanks of different shapes. For the PCE-28.Modbus-ALW transmitters, the set range is also related to the internal 4-20 mA current controller, where the start of the set range is assigned the value of 4 mA and it ends at 20 mA. This function allows readings to be displayed on the local LCD display in user-defined units relating to the entire or only part of the transmitter's basic range. When you wish to change the set range, to a range other than the basic one, adjust the display of the local LCD indicator to the changed setting. To do this, set the DC in the internal controller line in the Configuration Mode using the Modbus Configurator software to 4 mA, calibrate the LCD display for the set range start, then set the DC in the internal controller line to 20 mA and calibrate the LCD display for the end of the range accordingly. For operation of the LCD display in terms of calibration and the unit displayed, see [→8.7Operating the LCD display \(applies to PCE-28.Modbus-ALW\)](#).

8.3.4.2. Register 3, pressure of sensor 1

3	0x0002	Pressure of sensor 1	Pressure or level process variable	IEEE754	4 bytes (2 registers)
---	--------	-----------------------------	------------------------------------	---------	-----------------------

Basic process variable (pressure or level) standardized for the selected physical unit. This value is sent in 4-byte floating point format conforming to IEEE754. The maximum readable pressure or level range lies between:

[Lower sensor limit – 0.5 x (Upper sensor limit – Lower sensor limit)], and
 [0.5 x (Upper sensor limit – Lower sensor limit) + Upper sensor limit].

If the lower sensor limit is designated Pd and the upper sensor limit is designated Pg, then the transmitter's maximum possible processing range can be described as:

$P = [Pd - 0,5x(Pg - Pd) \dots Pg + 0,5x(Pg - Pd)]$

example:

A pressure transmitter for which Pd=0 kPa, Pg=100 kPa will process pressure in the range of -50 kPa to +150 kPa. If the pressure continues to increase beyond the permissible range, the read value will not change.

8.3.4.3. Register 5, pressure of sensor 2

5	0x0004	Pressure of sensor 2	Constant 0	IEEE754	4 bytes (2 registers)
---	--------	-----------------------------	------------	---------	-----------------------

Standby register. Data variables to be read are always zero.

8.3.4.4. Register 7, temperature of sensor 1

7	0x0006	Temperature of sensor 1	Sensor 1 temperature process variable at °C	IEEE754	4 bytes (2 registers)
---	--------	--------------------------------	---	---------	-----------------------

Value of the temperature process variable in °C read from the transmitter's measuring head. This value reflects the temperature of the measuring sensor and an approximate temperature of the medium (depending on the application).

8.3.4.5. Register 9, CPU temperature

9	0x0008	CPU temperature	CPU temperature process variable at °C	IEEE754	4 bytes (2 registers)
---	--------	------------------------	--	---------	-----------------------

Value of the temperature process variable in °C read from the microcontroller temperature sensor. This value reflects the approximate temperature of the transmitter electronics board.

8.3.4.6. Register 11, temperature of sensor 2

11	0x000A	Temperature of sensor 2	Constant 0 °C	IEEE754	4 bytes (2 registers)
----	--------	--------------------------------	---------------	---------	-----------------------

Standby register. Data variables to be read are always zero.

8.3.4.7. Register 13, standby

13	0x000C	-----	-----	-----	4 bytes (2 registers)
----	--------	-------	-------	-------	-----------------------

Standby register. Data variables to be read are always zero.

8.3.4.8. Register 15, standby

15	0x000E	-----	-----	-----	4 bytes (2 registers)
----	--------	-------	-------	-------	-----------------------

Standby register. Data variables to be read are always zero.

8.3.4.9. Register 17, user value

17	0x0010	User specific	1/100% of the controlled set range	Signed 16-bit int	2 bytes (1 register)
----	--------	---------------	------------------------------------	-------------------	----------------------

A given value has been described in Register 1. Outside this index, it also occurs in a 16-bit integer version with a sign.

8.3.4.10. Register 18, pressure of sensor 1 – binary format, integer and sign

18	0x0011	Pressure of sensor 1	Integer, 1/100 of the pressure or level unit	Signed 16-bit int	2 bytes (1 register)
----	--------	----------------------	--	-------------------	----------------------

Value of the primary process variable (pressure) standardized for the selected physical unit of pressure (or level). This value is an integer sent in scalable binary format as a value 100 times greater than the value of the sensor 1 pressure process variable.

Caution! The measuring range for a scalable integer, including its sign, is in the range of -32767 to 32767 units. If this range is exceeded, a false value will be read. In case of pressure reading in binary format “Signed 16-bit int”, the basic unit should be selected so that 100 times the pressure value does not exceed the above range.

8.3.4.11. Register 19, pressure of sensor 2

19	0x0012	Pressure of sensor 2	Value 01/100 of the selected unit.	Signed 16-bit int	2 bytes (1 register)
----	--------	----------------------	------------------------------------	-------------------	----------------------

Standby register. Data variables to be read are always zero.

8.3.4.12. Register 20, temperature of sensor 2 – binary format, integer and sign

20	0x0013	Temperature of sensor 2	Integer, 1/100°C	Signed 16-bit int	2 bytes (1 register)
----	--------	-------------------------	------------------	-------------------	----------------------

Value of the temperature process variable in °C read from the transmitter’s measuring head. This value is an integer sent in scalable binary format as a value 100 times greater than the value of the sensor 1 temperature process variable. This value reflects the temperature of the measuring sensor and an approximate temperature of the medium (depending on the application).

8.3.4.13. Register 21, CPU temperature – binary format, integer and sign

21	0x0014	CPU temperature	Integer, 1/100°C	Signed 16-bit int	2 bytes (1 register)
----	--------	-----------------	------------------	-------------------	----------------------

Value of the temperature process variable in °C read from the transmitter’s CPU. This value is an integer sent in scalable binary format as a value 100 times greater than the value of the CPU temperature process variable. This value reflects the temperature of the transmitter’s electronic circuits.

8.3.4.14. Register 22, temperature of sensor 2

22	0x0015	Temperature of sensor 2	Signed 16-bit int	00 00	2 bytes (1 register)
----	--------	-------------------------	-------------------	-------	----------------------

Standby register. Data variables to be read are always zero.

8.3.4.15. Register 23, pressure unit

23	0x0016	Pressure unit		Unsigned 16-bit int	00 0C	2 bytes (1 register)
----	--------	----------------------	--	---------------------	--------------	----------------------

Binary value corresponding to the pressure unit. The table below shows the units used.

Unit	Value (decimal number)	Unit	Value (decimal number)
atm	14	mbar	8
bar	7	mmH2O in 4°C	239
FtH2O	3	mmH2O	4
g/cm ²	9	mH2O in 4°C	171
lnH2O in 4°C	238	mmHg	5
lnHg	1	MPa	237
kg/cm ²	2	Pa	11
kPa	10	psi	6
mbar	12	torr	13

8.3.4.16. Register 24, standby

24	0x0017	-----	-----	-----	2 bytes (1 register)
----	--------	-------	-------	-------	----------------------

Standby register. Data variables to be read are always zero.

8.3.4.17. Register 25, standby

25	0x0018	Upper sensor limit	Upper limit of the basic range	IEEE754	4 bytes (2 registers)
----	--------	---------------------------	--------------------------------	---------	-----------------------

An upper value of the transmitter's basic range expressed in the transmitter's pressure units. This value is sent in 4-byte floating point format conforming to IEEE754.

8.3.4.18. Register 27, standby

27	0x001A	Lower sensor limit	Lower limit of the basic range	IEEE754	4 bytes (2 registers)
----	--------	---------------------------	--------------------------------	---------	-----------------------

A lower value of the transmitter's basic range expressed in the transmitter's pressure units. This value is sent in 4-byte floating point format conforming to IEEE754.

8.3.4.19. Register 29, standby

29	0x001C	Damping value	The seconds [s]	IEEE754	4 bytes (2 registers)
----	--------	----------------------	-----------------	---------	-----------------------

A damping block time constant in the transmitter in seconds. This value is sent in 4-byte floating point format conforming to IEEE754.

8.3.4.20. Register 31, response delay value

31	0x001E	Response delay value	Milliseconds [ms]	Unsigned 16-bit int	2 bytes (1 register)
----	--------	-----------------------------	-------------------	---------------------	----------------------

It is a value of response delay subsequent to the "Master" request. It describes the time between the end of a bit stop byte of the message checksum and a bit start byte of the response message address. This time depends on the speed of transmission and always exceeds 3.5T. This time may be useful in designing the time of a measurement cycle in a Modbus network.

8.3.4.21. Register 32, Modbus address

32	0x001F	Modbus Address	1 ... 247	Unsigned 8-bit int	2 bytes (1 register)
----	--------	----------------	-----------	--------------------	----------------------

Values of the transmitter’s network address register. The address is sent using 2 bytes. The first older byte is always zero. The second lower byte is used for the address. The address can be set in the range of 1 to 247. Each transmitter connected to the network must have a unique network address. If the same address is assigned to more than one transmitter, the “Master” will not be able to communicate with all present transmitters on the bus.

8.3.4.22. Register 33, identity register

33	0x0020	Identity register		Unsigned 8-bit int	6 bytes (3 registers)
----	--------	-------------------	--	--------------------	-----------------------

An identifier of the manufacturer, type and serial number of the transmitter. A unique identifier, different for each transmitter.

Identification of bytes according to the transmission sequence:

- 1st byte – insignificant, always 0;
- 2nd byte – manufacturer’s number acc. to HCF, APLISENS number: 188 dec (BC hex);
- 3rd byte – device type number, number for the transmitters described in this document: 125 dec (7D hex);
- 4th-6th byte – 24-bit binary identification number of the device. This number identifies the date of manufacture and serial number.

8.3.4.23. Register 36, status register

36	0x0023	Status register		8-bit flags	2 bytes (1 register)
----	--------	-----------------	--	-------------	----------------------

A 2-byte register monitoring the functioning of the transmitter’s subsystems. Events and the transmitter’s irregularities modify bits contained in the Modbus register below:

15	14	13	12	11	10	9	8	7	6	5	4	3	2	1	0
0	0	0	0	0	0	0	0	0	SV,TV,FV out of limit	PV out of limit	0	0	0	0	0

These irregularities can be identified in detail in configuration mode with the use of programmes such as e.g. Raport 2 from APLISENS S.A.

8.4. Configuration mode

8.4.1. “Modbus Configurator” software. Serial port configuration, Modbus network scanning, single transmitter search

The transmitter software version 17 and above allows you to perform basic actions or parameter changes via Modbus functions as described in section →8.3 Application layer, description of implemented functions. However, to make out specific settings or calibration operations, the transmitter must be adjusted using the APLISENS S.A. software. (link to software):

https://aplisens.pl/download/pliki_do_pobrania/Modbus%20Configurator%20Setup.exe.

Modbus Configurator to the configuration mode by pressing the respective program key. For operation in the configuration mode, it is recommended to disconnect the transmitter to be configured from the Modbus network and connect it directly to an RS485 converter coupled to a PC/Windows computer with the Modbus Configurator software installed.

Proceeding when a change of parameters of one of the Modbus network transmitters is required:

To change settings or perform calibration operations on the transmitter in the configuration mode, disconnect it from the Modbus network. If this is not possible, stop the master process controller that supports the Modbus network and plug in an additional PC-based master with the Modbus Configurator software to proceed with the configuration.



After launching the Configurator, open the tab Serial port settings and set the number of COM port to which the RS485 converter is connected, Modbus baud rate, parity mode and stop bits for the transmitters in the network.

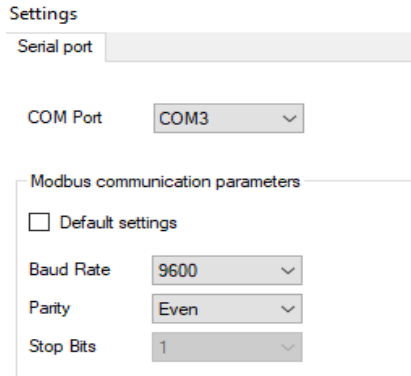

Serial port settings (example).

Next, search for Modbus transmitters according to address by clicking on “Scan Modbus network” (see figure below).

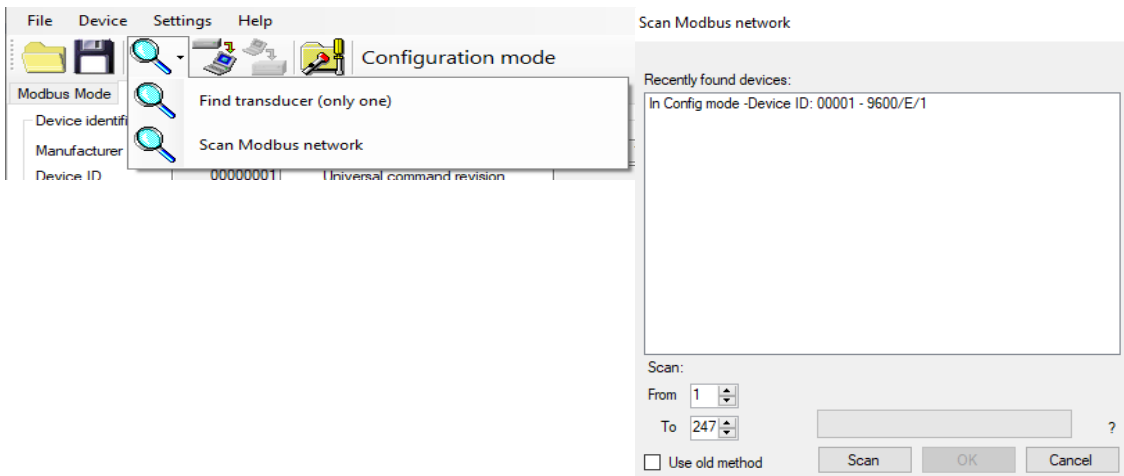

When searching the network, a list of Modbus transmitters from Aplisens S.A., connected to the network, will be displayed. If you know the network address of the transmitter to be set up, click on the appropriate transmitter in the scanned list. A list of registers will appear with read-out parameters from Modbus registers.

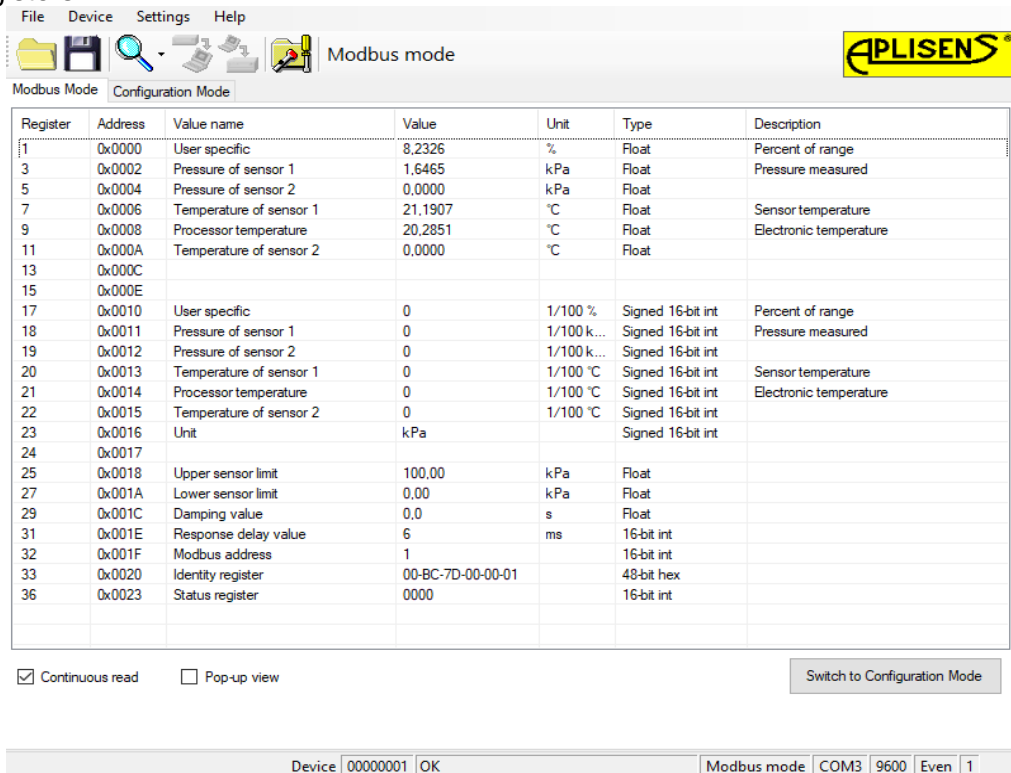

Switch the transmitter from Modbus into configuration mode working with Hart communication protocol.

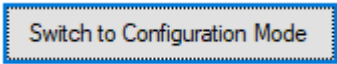

The procedure to be followed, if it is required to reconfigure parameter or identify an individual transmitter not connected via the Modbus network with other transmitters:

If the user wishes to identify an individual transmitter and they are not sure whether it is operating in the Modbus or Configuration modes, they shall use the "Find transducer (only one)" option.

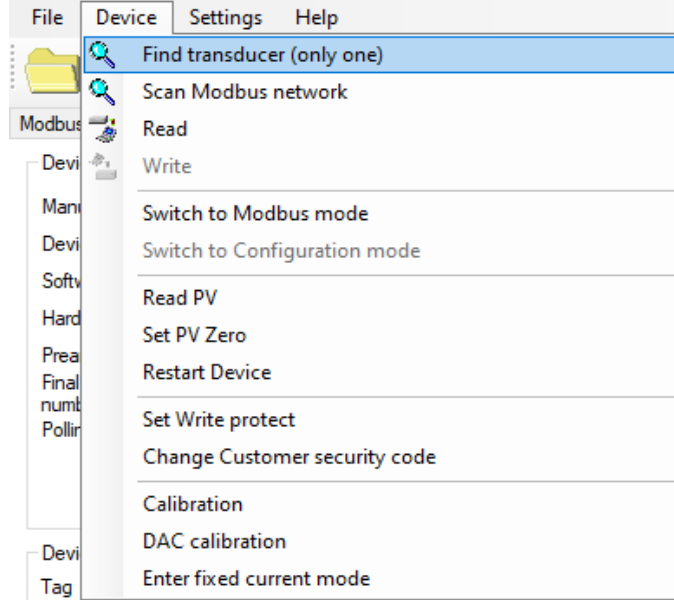

Transmitter search parameters related to potential transmission settings must be configured in the opened window. When in doubt, as to the range of settings, the best solution is to tick all the options. Clicking the "Scan" button prompts the programme to start searching for a transmitter, in a sequence, starting from the Configuration mode, and then it will go through an indicated range of transmission speeds and parity in the Modbus mode.

Searching for a transmitter in the Modbus mode is carried out with a broadcast = 0. Therefore, only one transmitter may be connected, when scanning through a communication bus. Where there are a larger number of transmitters operating in the Modbus mode connected to the bus and set to the same transmission parameters - sending a broadcast address will make transmitters respond to a request message at the same time, causing data corruption and an unreadable answer.

Search device (only one on the bus)

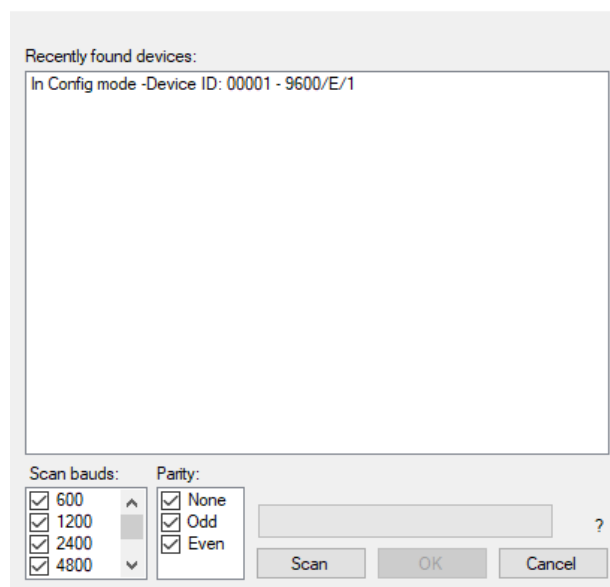

Click on the detected transmitter... A list of registers will appear with parameters read out from Modbus registers.

Register	Address	Value name	Value	Unit	Type	Description
1	0x0000	User specific	8.2894	%	Float	Percent of range
3	0x0002	Pressure of sensor 1	1.6579	kPa	Float	Pressure measured
5	0x0004	Pressure of sensor 2	0.0000	kPa	Float	
7	0x0006	Temperature of sensor 1	21.2286	°C	Float	Sensor temperature
9	0x0008	Processor temperature	20.3854	°C	Float	Electronic temperature
11	0x000A	Temperature of sensor 2	0.0000	°C	Float	
13	0x000C					
15	0x000E					
17	0x0010	User specific	0	1/100 %	Signed 16-bit int	Percent of range
18	0x0011	Pressure of sensor 1	0	1/100 k...	Signed 16-bit int	Pressure measured
19	0x0012	Pressure of sensor 2	0	1/100 k...	Signed 16-bit int	
20	0x0013	Temperature of sensor 1	0	1/100 °C	Signed 16-bit int	Sensor temperature
21	0x0014	Processor temperature	0	1/100 °C	Signed 16-bit int	Electronic temperature
22	0x0015	Temperature of sensor 2	0	1/100 °C	Signed 16-bit int	
23	0x0016	Unit	kPa		Signed 16-bit int	
24	0x0017					
25	0x0018	Upper sensor limit	100.00	kPa	Float	
27	0x001A	Lower sensor limit	0.00	kPa	Float	
29	0x001C	Damping value	0.0	s	Float	
31	0x001E	Response delay value	6	ms	16-bit int	
32	0x001F	Modbus address	1		16-bit int	
33	0x0020	Identity register	00-BC-7D-00-00-01		48-bit hex	
36	0x0023	Status register	0000		16-bit int	

Continuous read
 Pop-up view
 Switch to Configuration Mode

Then, switch the transmitter from the Modbus mode to the Configuration mode.

Switch to Configuration Mode

Device: 00000001 OK Modbus mode: COM3 9600 Even 1

Device identification

Manufacturer ID: 188	Device type code: 125	Lower sensor limit: 0 kPa
Device ID: 00000001	Universal command revision: 5	Upper sensor limit: 100 kPa
Software revision: 17	Transmitter-specific command rev.: 1	Minimum span: 10 kPa
Hardware revision: 66	Device function flags: 1	Lower range value: 0 kPa
Preambles: 5	Private label distributor code: 250	Upper range value: 20 kPa
Final assembly number: 0	Sensor serial number: 1	Unit: kPa
Polling address: 0	Modbus address: 1	PV: 1,663 kPa

Read PV 5,330 mA

Device information

Tag:

Descriptor:

Message:

Date: 2011.01.01

Damping value: 0.0 s

Transfer function: Linear

Processing time: 230 ms

Return to factory settings

Undo: Zero trim Sensor trim Analog output trim Undo

Write protection

Write protected: No Yes Set Write protect Change Customer security code

Set PV Zero Restart Device Switch to Modbus mode

Configuration mode: COM3 1200 Odd 1

Configuration mode view

8.4.2. Transmitter identification data

Device identification	
Manufacturer ID	188
Device ID	00000001
Software revision	17
Hardware revision	66
Preambles	5
Final assembly number	0
Polling address	0
Device type code	125
Universal command revision	5
Transmitter-specific command rev.	1
Device function flags	1
Private label distributor code	250
Sensor serial number	1
Modbus address	1

Identification data frames (example). Read-only values are shaded.

Read-only information fields:

- **Manufacturer ID** - manufacturer’s code according to HCF (HART) specifications.
- **Device ID** - transmitter’s serial number.
- **Software revision** - CPU software version.
- **Hardware revision** - transmitter’s PCB version.
- **Preambles** - number of preambles used for communication in configuration mode.
- **Pooling address** - address used for communication in configuration mode.
- **Device type code** – code indicating the transmitter type.
- **Universal command revision** - number in configuration mode.
- **Transmitter-specific command revision** – number in configuration mode.
- **Device function flags** – related to record handling type.
- **Private label distributor code**.

Editable information fields:

- **Final assembly number** of the device, recorded in binary format using 3 bytes, an integer in the range of 0...16777215 used for identification (modifiable by user).
- **Sensor serial number**, recorded in binary format using 3 bytes, an integer in the range of 0...16777215 used for identification (modifiable by user).
- **Modbus address**, an integer in the range of 1...247 (modifiable by user).

The field “**Modbus address**” used for defining the transmitter’s network address is highly significant.

8.4.3. Reading the transmitter’s limit values process variables

Process values	
Lower sensor limit	0 kPa
Upper sensor limit	100 kPa
Minimum span	10 kPa
Lower range value	0 kPa
Upper range value	20 kPa
Unit	kPa
PV	-0,082 kPa
Read PV	3,934 mA

Frame containing process variables and limit values (example)

- **Lower sensor limit** A read-only value. If exceeded, accuracy of measurements using the transmitter cannot be guaranteed. However, the transmitter will continue to process measuring signals up to 50% of the basic range below this point.
- **Upper sensor limit** A read-only value. If exceeded, accuracy of measurements using the transmitter cannot be guaranteed. However, the transmitter will continue to process measuring signals up to 50% of the basic range above this point.
- **Minimum span** A read-only value that defines the minimum width of the set range, modifiable by user by changing the start and/or the end points of the range. This parameter is also important when calibrating pressure or level. If intervals between calibration points are insufficient, the transmitter cannot be calibrated.
- **Lower range value** Value related to the current loop mode: 4-20 mA. Specific pressure or level is assigned to the current of 4 mA.
- **Upper range value** Value related to the current loop mode: 4-20 mA. Specific pressure or level is assigned to the current of 20 mA.
- Standard **Unit** is the physical unit used for standardizing measurements performed with the transmitter (definable by user).
- **PV** is the value of the pressure or level process variable, standardized basic unit as defined. Additionally, the current process variable is displayed.

To refresh the value, click on the button “**Read PV**”.

8.4.4. Reading alphanumeric identification data

Device information	
Tag	AE-01234
Descriptor	GAS BOILER BLOCK
Message	PROTECTION CONTROL 2003
Date	2023.01.01

Alphanumeric identification data frame (example).

User can read or modify the transmitter's alphanumeric identification data.

Tag is an 8-character alphanumeric field where you can enter e.g. an identification number of the transmitter in the system. This field can contain digits and capital letters without diacritics.

Descriptor is a 16-character alphanumeric field where you can enter a short description of e.g. an installation site. This field can contain digits and capital letters without diacritics.

Message is a 32-character alphanumeric field where you can enter a longer description. This field can contain digits and capital letters without diacritics.

8.4.5. Damping and transfer function

Damping value	0,0 s	
Transfer function	Linear	
Processing time	230 ms	
	Quickly	Precisely

User can read or modify the measurement damping value and transfer function type.

Damping value is expressed in seconds and describes the duration of a non-determined status after which the process variable will achieve 63.2% of the total value change. The process variable value will be nearly fully changed with an accuracy of below 1% after ca 5 time constants.

The transfer function determines the method of transforming a process variable related to pressure measurement / pressure differences into a control value of a process output (current or a percentage value of the set range). The following functions are available from a drop-down list:

- linear;
- root;
- quadratic;
- user.

The control value of a process output transformed with a transfer function is available in Modbus 1 and 17 registers.

8.4.6. Modbus mode

Modbus mode	
Baud rate	9600
Parity	Even
Stop Bits	1
<input type="checkbox"/> Default settings	

User can read or edit and save Modbus RTU baud rate and parity control mode or restore default settings.

8.4.7. Restore default settings

User can restore default settings for the following parameters:

- Zero-point calibration.
- Pressure sensor calibration.
- Analogue output calibration. In case of changing the set range in PCE-28.Modbus-ALW, the local LCD display must be recalibrated. The procedure of this calibration is described in chapter [→8.7 Operating the LCD display \(applies to PCE-28.Modbus-ALW\)](#).

You can restore default settings if you changed some settings accidentally and you are not able to perform calibration to your own settings. Please remember that this operation will restore calibration settings defined by the manufacturer. If you have already calibrated the transmitter to your own settings, all your calibration settings will be lost as a result of this operation.

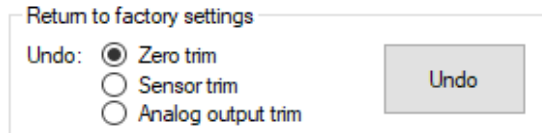

8.4.8. Write lock



You can set a lock that prevents from modification of the transmitter parameters and change the security code to remove the lock. The lock code has a format of 8 hexadecimal characters, i.e. in the range 0...9, A-F, **the default value is 00000000**.

It is not possible to change the transmitter settings when the lock is activated.

8.4.9. Additional operation

User can perform additional operations on the transmitter:

- Set PV Zero enables resetting pressure in a non-pressurized transmitter. The resetting option is used for eliminating any deviations of the zero point caused by installation (position or stress). The operation cannot be performed if deviation of the zero point exceeds the permissible limit or if the transmitter measures absolute pressure.
- Restart Device enables sending a command to hot restart the transmitter without the need to disconnect the power supply.



8.4.10. Calibrations

User can perform 2-point pressure calibration, DAC (analogue) calibration and, in addition to that, enter fixed current mode.

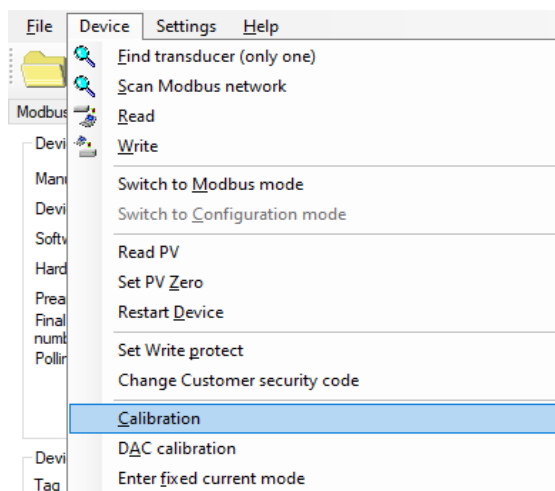

8.4.10.1. Pressure or differential pressure calibration.

To open the pressure or differential pressure tab, select Device → Calibration on the top bar of the programme screen.

Calibration of the lower and upper pressure limits should be best performed for the transmitter's standard measuring range. For metrological reasons, if the used range is only an insignificant section of the standard range, the transmitter should be calibrated based on the lower and upper limits of the used range. The calibration procedure involves supplying reference pressure to the transmitter for the lower calibration point. The reference pressure or differential pressure should be entered into the set value field. As soon as the read value is stable, press "Calibrate". If calibration is successful, an appropriate message will appear. Repeat the above steps for the upper pressure limit.

If the difference between the reference pressure and the actual pressure read by the transmitter exceeds the permissible limit, calibration will not be performed and an appropriate message will be displayed. A similar situation arises if the selected calibration point lies outside the transmitter's lower or upper limit.

8.4.10.2. Calibrating the analogue output

Select the "Device → DAC calibration" option in the top bar to access the analogue output calibration tab. With the calibration wizard, you can perform a two-point calibration of the low (4 mA) or high (20 mA) current. For the PCE-28.Modbus-ALW transmitters with an on-board LCD, it is not advisable to use the analogue output calibration function. However, if it is used, the local LCD must be recalibrated afterwards. The calibration procedure is described in section →8.7 Operating the LCD display (applies to PCE-28.Modbus-ALW).

8.4.10.3. Setting the fixed current mode

To enter fixed current mode tab, select "Device → Enter fixed current mode," in the top bar. In this mode, on transmitters equipped with a current controller, you can set the controller current between 3.600 and 23.000 mA for testing purposes, e.g. 4.000 mA and 20.000 mA. In the PCE-28.Modbus-ALW transmitters, this option is useful for calibrating the local LCD display (after changing the set range, after analogue output calibration, after the analogue output reset to factory defaults, after changing analogue output conversion curve or if the local LCD display unit change is required). The procedure for calibrating of the local LCD display is described in →8.7 Operating the LCD display (applies to PCE-28.Modbus-ALW).

8.4.10.4. Configuration write

Once the parameters have been configured save the changes to the transmitter. To do this, select the "Device → Write" on the top bar of the program or press the save configuration icon.



8.5. Current loop 4-20 mA operation (applies to PCE-28.Modbus and PRE-28. Modbus) or with an internal 4-20 mA current controller (applies to PCE-28.Modbus-ALW)

8.5.1. Set range

If you change the range set on the PCE-28.Modbus-ALW the local LCD display must be recalibrated. The calibration procedure is described in section →8.7 Operating the LCD display (applies to PCE-28.Modbus-ALW). The set range is a parameter linked to the “user value” or “% control of the set range” process variable (log 1 and 17) and, at the same time, to the control value of the current controller controlling the display of the local LCD indicator. The LRV point of the set range corresponds to the controller current of 4.000 mA, and the URV point to 20.000 mA. The LRV and URV points can be assigned different pressure values from the transmitter's basic range, subject to the minimum range span condition of the MSV setting. It is also possible to set a reverse curve, where the LRV point is assigned a higher pressure than the URV, subject to the minimum range span condition of the MSV setting. The figure below shows the transmitter set range and limits related to allowable set range, digital processing range and saturation limits of A/D pressure measurement transducer. As standard, values of 4 mA/20 mA currents are assigned to LRV/URV points. In order to obtain reverse characteristics, it is possible to reverse the assignment so that the LRV/URV points are assigned to 20 mA/4 mA currents.

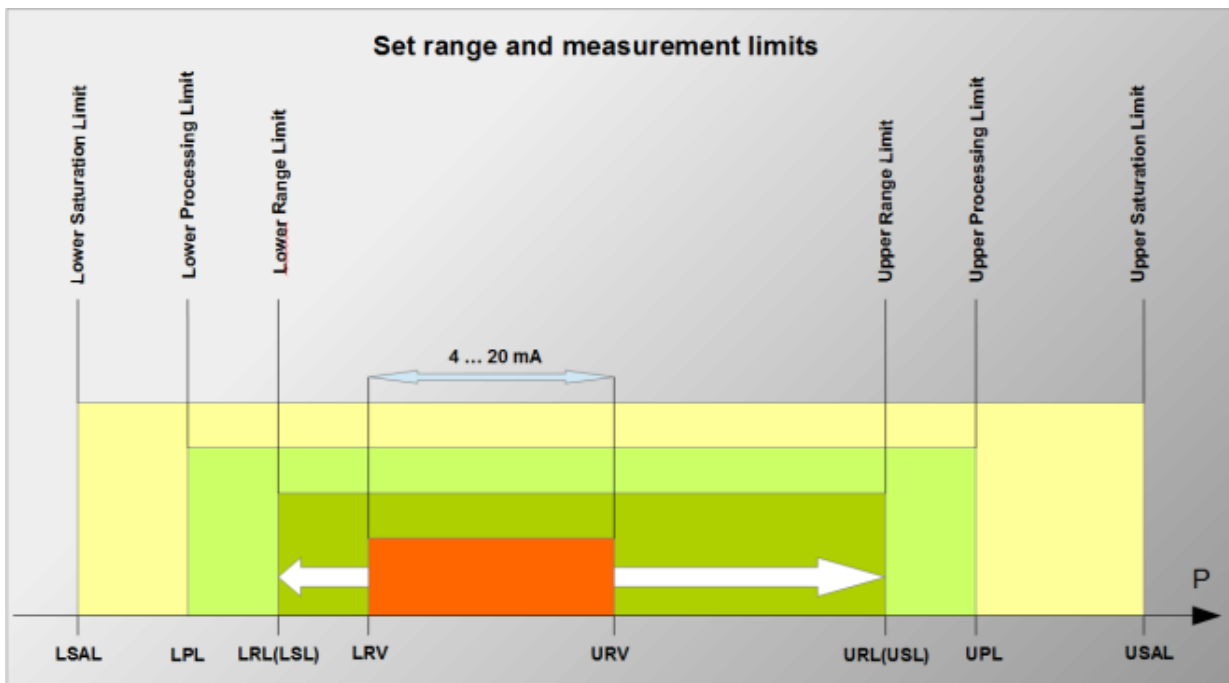

Figure 3 Set range and measurement limits

Table 4 Set range and measurement limits

Set range and measurement limits		
Item no.	Abbr.	Meaning
1	LRV	"Lower Range Value" – the value of the set range expressed in physical units corresponding to the current of 4,000 mA, i.e. 0% of the output setpoint. The set range cannot exceed the set range limits. The minimum width of the set range $ (URV-LRV) $ is limited to 10% of the base range (URL-LRL).
2	URV	"Upper Range Value" – the value of the set range expressed in physical units corresponding to the current of 20,000 mA, i.e. 100% of the output setpoint. The set range cannot exceed the set range limits. The minimum width of the set range $ (URV-LRV) $ is limited to 10% of the base range (URL-LRL).
3	LRL LSL	"Lower Range Limit" or "Lower Sensor Limit" - lower limit of set range expressed in physical units. Value (URL-LRL) or (USL-LSL) is referred to as the base transmitter range.
4	URL USL	"Upper Range Limit" or "Upper Sensor Limit" – upper limit of set range expressed in physical units. Value (URL-LRL) or (USL-LSL) is referred to as the base transmitter range.
5	LPL	"Lower Processing Limit" – lower limit of digital processing of measured value. The transmitter processes a digital measurement up to 50% of the base range width below the lower limit of set range LRL (LSL) . After reaching the LPL and when below this value up to LSAL , the transmitter freezes the refreshing of digital value of the measurement.
6	UPL	"Upper Processing Limit" – upper limit of digital processing of measured value. The transmitter processes a digital measurement up to 50% of the base range width above the upper limit of set range URL (USL) . After reaching the UPL and when above this value up to USAL , the transmitter freezes the refreshing of digital value of the measurement.
7	LSAL	"Lower Saturation Limit" - lower limit of the ADC transmitter processing range. The lower limit of the ADC transmitter saturation is on the pressure/differential pressure scale below the LPL point and is associated with the minimum pressure, at which the analogue-digital pressure measurement transmitter reaches the lower limit of the processing capacity. Exact determination of this pressure is not possible, but it exceeds the pressure corresponding to 30 times the span of the (URL-LRL) basic range below the lower limit of digital processing of the UPL measured value. After reaching LSAL and when below this value diagnostic alarm mode will be activated depending on the settings $I_AL < 3,650$ mA or $I_AL > 21,500$ mA.
8	USAL	"Upper Saturation Limit" - upper limit of the A/D transmitter processing range. The upper limit saturation point of A/D transmitter is on the pressure/differential pressure scale above the UPL point and is associated with the maximum pressure at which the analogue-digital pressure measurement transmitter reaches the upper limit of the processing capacity. Exact determination of this pressure is not possible, but it exceeds the pressure corresponding to 30 times the span of the (URL-LRL) basic range above the upper limit of digital processing of the UPL measured value. After reaching LSAL and when above this value diagnostic alarm mode will be activated depending on the settings $I_AL < 3,650$ mA or $I_AL > 21,500$ mA.
9	AL_L	Low current alarm.
10	AL_H	High current alarm.
11	MSV	"Minimum Span Value" – the value of the minimum span of the $ URV - LRV $ range setting possible to set in the transmitter. This value is written into the transmitter at the manufacturing stage and cannot be changed by the user.

8.5.2. Alarm signal levels

With the PCE-28.Modbus-ALW transmitters, the current alarm signals are software disabled, as the current signal of the internal current regulator is only used to control the local LCD indicator. In other types of Modbus transmitters, where the controller current signal is routed outside, alarm signals can be detected with an external controller.

The nominal value of the AL_L low alarm current is 3.600 mA.

The nominal value of the AL_H high alarm current is 22.000 mA.

The alarm mode is activated in the following cases:

- ADC converter fault;
- local quartz oscillator fault;
- dynamic RAM fault;
- coefficient memory or the FLASH program memory fault.

8.6. Modbus mode

After configuring the transmitter as necessary to restore Modbus mode, you must save new settings. Click on the button Switch to Modbus mode to save new settings and switch the transmitter into Modbus communication mode.

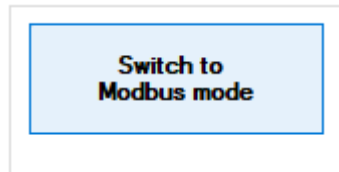

8.7. Operating the LCD display (applies to PCE-28.Modbus-ALW)

8.7.1. Local LCD display

Display options can be changed in local MENU using buttons. The display is shown in the figure below.

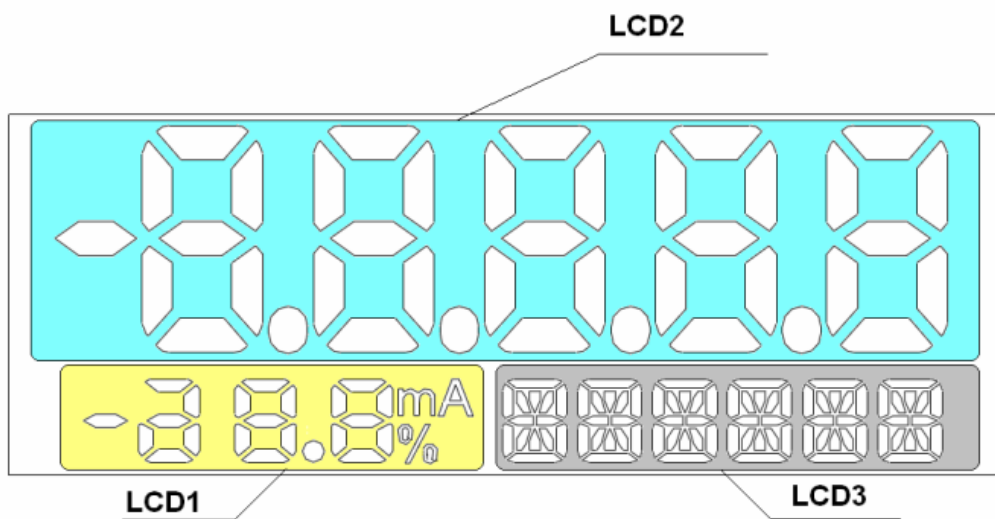

Figure 4 LCD Display

There are three basic fields on the display:

- **LCD1** – value of current or guidance percent preset range display. Depending on the display configuration will be displayed the current value of the current line 4...20 mA with a resolution of 0.1 mA, or percent guidance the preset range with a resolution of indications 1%.
- **LCD2** – display field for the digital value measured by display, the value rescaled by user's units, and error codes. The position of the decimal point can be set in the local MENU.
- **LCD3** – information field. During normal operation it is designed for continuous display of the base unit or the user units. In the MENU operation mode it displays the setting options. It is also used to display errors related to the execution of commands in the local setup MENU.

8.7.2. Display configuration

The user can change the display settings using the buttons below the display. The buttons can be accessed by unscrewing the display cover. The buttons are marked with symbols: [↓], [↑] and [●]. The buttons [↓], [↑] are used to move up and down the MENU structure, and the button [●] confirms and executes the selected option. Pressing and holding any button for about 4 seconds will cause enter to the local setting mode, and the following message "EXIT" appears on the display in the field LCD3. No activity in the MENU area for longer than 2 minutes automatically exits the local setting mode and goes to display process variable. After confirming the selected parameter, the display will confirm the acceptance of the command with a "DONE" message. The "← BACK" button allows to move up a level higher in the MENU structure.

The way of navigating in the MENU structure of the local display is shown in the diagram below.

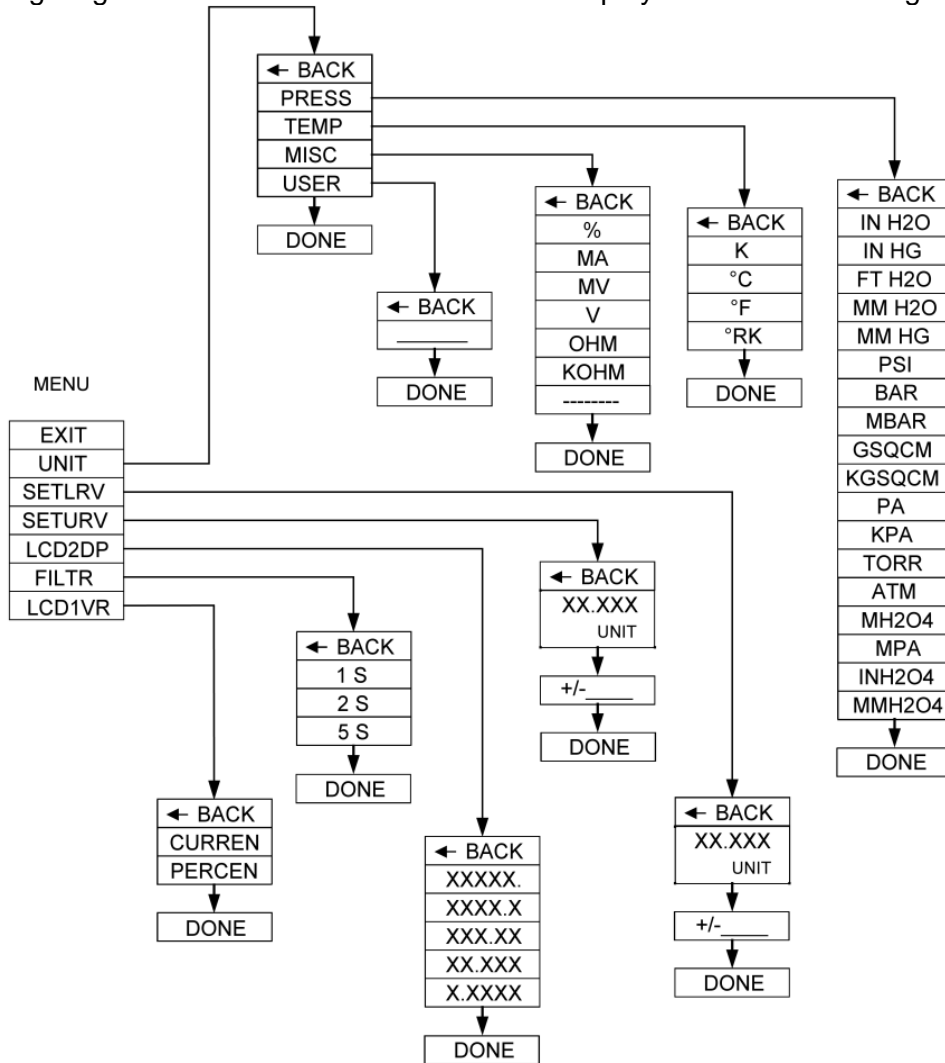

Figure 5 Structure of the local setpoints MENU

8.7.3. Local Menu, error messages

Local Menu		Description																
EXIT		Return from local Menu to display the process variable.																
UNIT		Set up of units.																
	PRESS	Switching to the selection of pressure units.																
	TEMP	Switching to the selection of temperature units.																
	MISC	Switching to the selection of different units.																
	USER	Switching to the user's units entry.																
	_____	Enter the user's unit value (six alphanumeric characters). Buttons "↑" or "↓" are used to select each alphanumeric character of the entered unit. Addition of successive character is made by confirmation of the previous character (by pressing [●] button). After confirmation of the last (6 th) character, the device will confirm the command with "DONE" message or report an error number.																
SET LRV / SET URV		Function allows to assign the given values corresponding to the output signals 4 and 20 [mA]. Value after linear scaling is displayed in the LCD2 field. User can set any value of start and end of the range. By default, the LCD2 field displays the percentage of the measured range. <div style="text-align: right;"> </div> <table border="1" style="margin-top: 10px;"> <caption>Table. Exemplary settings LRV, URV.</caption> <thead> <tr> <th>Unit</th> <th>LRV</th> <th>URV</th> <th>LCD2</th> </tr> </thead> <tbody> <tr> <td>mA</td> <td>4</td> <td>20</td> <td>Current in current loop</td> </tr> <tr> <td>%</td> <td>0</td> <td>100</td> <td>Output setting percentage - set as a standard</td> </tr> <tr> <td>Measurement range unit (e.g. kPa)</td> <td>Range beginning (e.g. 0)</td> <td>Range end (e.g. 100)</td> <td>Measured physical value (e.g. pressure)</td> </tr> </tbody> </table>	Unit	LRV	URV	LCD2	mA	4	20	Current in current loop	%	0	100	Output setting percentage - set as a standard	Measurement range unit (e.g. kPa)	Range beginning (e.g. 0)	Range end (e.g. 100)	Measured physical value (e.g. pressure)
	Unit	LRV	URV	LCD2														
	mA	4	20	Current in current loop														
	%	0	100	Output setting percentage - set as a standard														
Measurement range unit (e.g. kPa)	Range beginning (e.g. 0)	Range end (e.g. 100)	Measured physical value (e.g. pressure)															
XX.XXX UNIT		Actual value of start and end of the displayed range will be presented. Confirmation of this option allows to assign the given value to the start and end of the displayed range.																
+/- _____		Entering value of set range. Buttons "↑" or "↓" are used to select entered character. Addition of successive figure is made by confirmation of the previous one (pressing [●] button). Changing the digit or setting a comma is made using button "↑" or "↓". After confirmation of the last (6 th) character, the device will confirm the command with "DONE" message or report an error number. Parameter is entered in UNIT units.																
LCD2DP		Change the position of the decimal point of variable presented in the LCD2 field of the display.																
FILTR		Selection of averaging time of displayed process variable.																
LCD1VR		Type of process variable presented in the LCD1 field of the display.																
	CURREN	Value of current in current loop will be presented in the LCD1 field.																
	PERCEN	Percentage value of input setting will be presented on the display.																

During the execution of some functions in the local Menu, the EXXXX error message (letter "E" and 4 digits of the error code) may be displayed on the LCD2 screen. Displaying an error means that the local Menu command was not carried out. The persistence of the error message for a long time proves the display is damaged or not working properly. Errors in the display or incorrect configuration of the display do not affect the value of the loop current process variable.

8.7.4. Basic technical parameter display

Electrical parameters: The LCD that converts a control current of 4...20 mA into a display programmed according to a preset scaling and a fixed unit.

Metrological parameters: Indication error: 0,2 % ± 1 digit.

9. MAINTENANCE

9.1. Periodic inspections

Periodic inspections shall be carried out in accordance with applicable standards. During the inspection, the condition of the pressure (absence of loosened elements and leaks) and electrical (check of connections reliability and condition of gaskets and glands) connectors, condition of separating diaphragms (tarnish, corrosion) and stability of fixing of the housing and mounting bracket (if used) shall be checked. Check the processing characteristics by performing the operations specific for the calibration and possibly configuration procedure described in EN.IM.PCE.PRE.SG.MOVBUS.

9.2. Non-periodic inspections

If the transmitter at the installation site has been exposed to mechanical damage, pressure overload, hydraulic pulses, overvoltage, deposits, medium crystallization, undercutting of the diaphragm, or incorrect operation of the transmitter is detected, the device should be inspected. Check the condition of the diaphragm, clean it, check the electrical functionality of the transmitter and the processing characteristics.



If there is no signal in the transmission line or its value is improper, check the supply line, connection status on terminal blocks, connectors, etc. Check if the supply voltage and load resistance are correct.

9.3. Cleaning/washing

To remove impurities from the external surfaces of the transmitter wipe it with a cloth dampened in water.

9.4. Diaphragm cleaning

The only possible method of cleaning the transmitter diaphragms is to dissolve the sludge produced.



Do not remove deposits and impurities from the transmitter diaphragms, which are formed during operation, mechanically using tools, since the diaphragms and the transmitter can be damaged.

9.5. Spare parts

Parts of the transmitter that may be worn or damaged and thus replaced:

- In the transmitter with PKD connection - terminal block with angular cover and gasket;
- In the transmitter with PM12 connection – connector PM12.
- In the transmitter with PKD connection – all connector.
- In the transmitter with PD connection – connector terminal block with angular cover and gasket, and connector base with gasket.



Other parts in the case of ATEX type of transmitter may be replaced only by the manufacturer or an authorized representative.

9.6. Repair

Faulty or non-operational transmitter shall be provided to the manufacturer.

9.7. Returns

In the following cases, the transmitter should be returned directly to the manufacturer:

- need for repair;
- need for factory calibration;
- replacement of improperly selected/shipped transmitter.

10. SCRAPPING, DISPOSAL



Worn or damaged devices shall be scrapped in accordance with WEEE Directive (2012/19/EU) on waste electrical and electronic equipment or returned to the manufacturer.

11. HISTORY OF REVISIONS

Revision No.	Document revision	Description of changes
-	01.A.001/2021.09	Initial document version. Replaces the revision 1_01.D.011_2020-01. Change of software, power supply, figures. Editorial changes. Prepared by DBFD.
1	01.A.002/2022.01	Updating the parameters according to the new certificate.
2	02.A.001/2022.12	Revisions due to the introduction of version 17 of the transmitter firmware, editorial changes. Prepared by the DBFD.

11.1. PCB and software versions

01-09-2022 – Introduction of version 17 of the transmitter firmware.

Version 17 of the software introduced the following changes:

- Modbus function 0x2B (43) Read Device Identification added.
- Modbus function 0x64 (100) Read coefficients added.
- Modbus function 0x65 (101) Write coefficients added.
- Modbus function 0x66 (102) Set Modbus Device Address (FLASH) added.
- Modbus function 0x67 (103) Set Speed, Parity, Stop added.
- Modbus function 0x68 (104) Perform Action added.
- Modbus function 0x69 (105) Set Modbus Device Address (RAM) added.
- Application layer management layout changed.
- Register addresses changed (doubled address value).

05-10-2017 - Implementation of version 16 of the transmitter firmware.

- Eliminating of damping time maximum limit.
- Introduction of new version of Modbus Configuration software numbered 2.2.0.204, from which there is the possibility of enter the maximum damping time without limit.

01-09-2015 – Supply voltage details for the 4-20 mA mode added.

24-06-2015 - Correction of pressure units for the codes 1, 2, 10, 12.

01-03-2015 - Implementation of version 15 of the transmitter firmware.

- The management of the data connection layer in the transmitter software has been improved. Under certain conditions, a transmitter may have failed to send a response to a correctly sent request message. The implemented patch has removed this fault.
- The option of reading a percentage value of the controlled set range from the transmitters in the Modbus mode has been added. A variable of the IEEE754 float type with a header is sent on 4 bytes:

Register	Address (hex)	Intended use	Notes	Format	Number of bytes (2 bytes per register)
1	0x0000	User value	% of the set range control	IEEE754	4 bytes (2 register)

A variable of the 16-bit integer type with a header is sent on 2 bytes:

17	0x0010	User value	1/100% of the set range control	Signed 16-bit int	2 bytes (1 register)
----	--------	------------	---------------------------------	-------------------	----------------------

The set range is defined in the Configuration mode:

Lower range value	<input type="text" value="0"/>	kPa
Upper range value	<input type="text" value="20"/>	kPa

The set range may be equal to or lower than the basic range. It is defined mostly to configure a transmitter to operate in the 4-20 mA current loop mode.

In this mode, the start of the set range corresponds to the current of 4mA and the control percentage of 0%, whereas the end of the set range corresponds to the current of 20mA and the control percentage of 100%. Both the value of current in a current loop in the 4-20mA mode and the percentage of the set range control may be converted with the transfer function defined in the Configuration mode.

In the Modbus operating mode, the percentage of the set range control (0-100) may be used by the user to convert this value into any other value, by performing a mathematical operation in a resolver. At the same time, when a root function is set in the transmitter, it may be used to read out flows through orifices or reducers.

- The information entered by a transmitter to register 31 in version 15 of the firmware describes the actual time between the end of a bit stop of the last byte of the CRC checksum in a request message and a bit start of the byte of the transmitter answer message (response time). This time depends on the set speed of transmitter transmission within the range from 3ms to 20ms.
- Small corrections increasing the comfort of use have been introduced to the Modbus Configurator software dedicated to transmitters, at the same time incrementing it to version 2.1.0.195.

01-07-2014 - Implementation of PCB version 48.

The 48 version of PCB introduced following changes:

- Miniaturized printed circuit board with reduced dimensions.
- Frequency of the CPU clock frequency changed from 14.74 to 3.68 MHz, reduced power consumption.
- Additional D/A transmitter and current source circuits to enable control in current loop mode (4 20 mA).
- Change in the way signals are connected to the M12 electrical connection.
- Greater resistance to EMI interferences.

01-07-2014 - Implementation of version 14 of the transmitter firmware.

The new version 14 of the firmware was designed in parallel with the introduction of version 48 of the electronic system, and it introduced the following changes:

- Eliminated option of a 10-bit word in serial transmission. Starting from the software version 14, in accordance with the Modbus RTU standard (“Modbus over Serial Line Specification and Implementation Guide v1.02”) one character always consists of 11 bits. If there is no parity bit, 2 stop bits are used to achieve 11 bits in the character frame. The following formats are used: 8E1 (default), 8O1, 8N2.
- Eliminated option of modifying the transmitter’s response delay. In the version 14 this time interval is set to 0 and depends on such factors as the number of data read using function 03, defined transfer rate and coincidence of the request with the transmitter’s automated programme. This time interval should not be greater than 5 ms.
- Eliminated Modbus transfer rate of 600 b/s.
- Reduced consumption and optimized input energy management.
- Optimized time-critical procedures.
- Implemented functions related to operation of the transmitters in current loop mode.
- Implemented functions related to configuration of the transmitters in current loop mode.

Appendix 1. Explosion-proof device manual EN.IO.PCE.PRE.28.MODBUS

PRESSURE/DIFFERENTIAL TRANSMITTERS TYPE:
 PCE-28.Modbus, PRE-28.Modbus, PCE-28.Modbus16, PRE-28.Modbus16
 INTRINSICALLY SAFE acc. to ATEX

1. Introduction

Explosion proof device manual EN.IO.PCE.PRE.28.MODBUS only applies to pressure and differential transmitters PCE-28.Modbus, PRE-28.Modbus. PCE-28.Modbus16, PRE-28.Modbus16 in intrinsically safe version acc. to ATEX marked as in point 2 and the Ex information in the Product Certificate. During installation and use of Ex transmitters it is necessary to use user's manual EN.IO.PCE.PRE.28.MODBUS with „Explosion-proof device manual EN.IO.PCE.PRE.28.MODBUS”.

2. Using transmitters in hazardous area.

The transmitters are produced in accordance with the requirements of the following standards:
 EN IEC 60079-0:2018, EN 60079-11:2012, EN 50303:2000.



2.1. The PCE-28.Modbus, PRE-28.Modbus transmitters with electrical connection PK, PKM, SG, SGM, PZ may operate in areas where there is a risk of explosion, in accordance with the rating of the explosion protection design:

 **I M1 Ex ia I Ma**
II 1/2G Ex ia IIC T4/T5/T6 Ga/Gb
II 2D Ex ia IIIC T110°C Db
FTZÚ 18 ATEX 0077X

2.2. The PCE-28.Modbus, PRE-28.Modbus transmitters with the PKD, PM12 electrical connection are approved only for explosive gaseous atmospheres and have the markings:

 **II 1/2G Ex ia IIC T4/T5/T6 Ga/Gb**
FTZÚ 18 ATEX 0077X

2.3. The PCE-28.Modbus16, PRE-28.Modbus16 transmitters with PZ, PZ4 electrical connection have the markings:

 **I M1 Ex ia I Ma** or  **II 1/2G Ex ia IIB T4 Ga/Gb**
FTZÚ 18 ATEX 0077X **II 2D Ex ia IIIC T110°C Db**
FTZÚ 18 ATEX 0077X

3. Permissible input parameters (based on data from the FTZÚ 18 ATEX 0077X)



For the connection of the power supply line and the RS485 data transmission signal line, use devices that have the relevant intrinsic safety certificates, whose parameters must not exceed the permissible input-output parameters given in points a) and b).



The transmitters should be powered from devices with galvanically separated power supply. If it is not possible to separate the galvanically separated power supply, the transmitter or the metal parts connected to it should be properly grounded, using, for example, a system of equalization wires or using an equalization connection between the transmitter and the minus of the power barrier.

3.1. Transmitters PCE-28.Modbus, PRE-28.Modbus with PK, PKM, PKD, PM12, SG, SGM, PZ connection.

Minimum transmitters supply voltage 4 V DC.

The transmitter is an intrinsically safe device with protection level "ia" when the power supply circuit has protection level "ia".

a) Permissible input parameters for power supply (red "+", black "-")

- for power supply with linear characteristics:

$$U_i \leq 10 \text{ V, } I_i \leq 0.4 \text{ A,}$$

EN.IX.PCE.PRE.28.MODBUS

- for power supply with rectangular and trapezoidal characteristics:

$$U_i \leq 5 \text{ V}, I_i \leq 0.4 \text{ A}$$

b) Permissible input and output parameters for RS485 transmission (blue VA, yellow VB):

$$U_i \leq 10 \text{ V}, I_i \leq 0.2 \text{ A}, U_o \leq 10 \text{ V}^*, I_o \leq 0.4 \text{ A}^*$$

* the output parameters of the transmitters U_o, I_o are equal to the output parameters U_o, I_o of the power supply used.

Dependence of temperature class of transmitters on ambient temperature (including temperature of measured medium) T_a [°C] and sum of power P_i [W] in power supply circuit and in RS485 transmission circuit is given in **Table Z1**.

Min. ambient temperature $T_a = -40^\circ\text{C}$ (special version from -50°C).

c) The internal capacitance and inductance of transmitter in the power supply circuit and in the RS485 transmission circuit is:

$$L_i = 0 \text{ } \mu\text{H}, C_i \approx 2.5 \text{ } \mu\text{F}^{**}$$

d) The maximum capacitance and inductance that can be connected to the transmitter in the transmission circuit is for the subgroup:

- IIC $L_o = 0.2 \text{ mH}, C_o = 0.5 \text{ } \mu\text{F}$;

- IIB $L_o = 0.7 \text{ mH}, C_o = 15 \text{ } \mu\text{F}$;

- IIA and group I $L_o = 1.7 \text{ mH}, C_o = 80 \text{ } \mu\text{F}$.

** Consider the cable capacitance and inductance, which for a permanently connected cable are:

$$C_k = 0,2 \text{ nF/m} \text{ i } L_k = 1 \text{ } \mu\text{H/m}$$

Transmitter with PK, PKM, PKD, PM12, SG, SGM, PZ connection, input capacitance C_w and inductance L_w with cable parameters:

$$C_w = C_i + a \cdot C_k = 2.5 \mu\text{F} + a \cdot 0.2 \text{ nF/m}$$

$$L_w = L_i + a \cdot L_k = 0 \mu\text{H} + a \cdot 1 \mu\text{H/m}$$

Where:

a - the length of the cable permanently mounted in the transmitter in meters.

Table Z1. Temperature class dependence on ambient temperature T_a and power sum P_i .

P_i [W] Sum of input powers in supply and transmission circuits 485	T_a [°C]	Class temp.	P_i [W] Sum of input powers in supply and transmission circuits 485	T_a [°C]	Class temp.	P_i [W] Sum of input powers in supply and transmission circuits 485	T_a [°C]	Class temp.
0.25	65	T6	0.75	55	T6	1.5	65	T5
	80	T5		80	T5		80	T4
0.5	60	T6	1.2	70	T5	1.75	60	T5
	80	T5		80	T4		80	T4

3.2. PCE-28.Modbus16, PRE-28.Modbus16 transmitters with PZ, PZ4 connection:

Minimum supply voltage 10,5 V DC.

a) Permissible input parameters for power supply (“+”, “-“)

- Permissible parameters for power supply for subgroups IIB, IIC:

$$U_i \leq 15,8 \text{ V}, I_i \leq 1.5 \text{ A}, L_i = 0 \text{ } \mu\text{H}, C_i = 0 \text{ } \mu\text{F}$$

- Permissible parameters for power supply for group I:

$$U_i \leq 15.8 \text{ V}, I_i \leq 2 \text{ A}, L_i = 0 \text{ } \mu\text{H}, C_i = 0 \text{ } \mu\text{F}$$

b) Input and output parameters for transmission RS485 (VA, VB)

$$U_i \leq 10 \text{ V}, I_i \leq 0.5 \text{ A}, P_i = 1,6 \text{ W}, L_i = 0 \text{ } \mu\text{H}, C_i = 2.5 \text{ } \mu\text{F}$$

$$U_o = 5.88 \text{ V}, I_o = 0.039 \text{ A}, P_o = 0.143 \text{ W},$$

$$\text{For gr. I + IIA } L_o = 3 \text{ mH}, C_o = 80 \text{ } \mu\text{F}, \text{ for IIB } L_o = 3 \text{ mH}, C_o = 40 \text{ } \mu\text{F}$$

4. Connection of transmitters in Ex version

Connections of the transmitters and devices in the transmitters measuring loop must be made in accordance with intrinsic safety and explosion protection standards and conditions of use in hazardous areas. Failure to observe the intrinsic safety rules may result in an explosion and resultant danger to people.

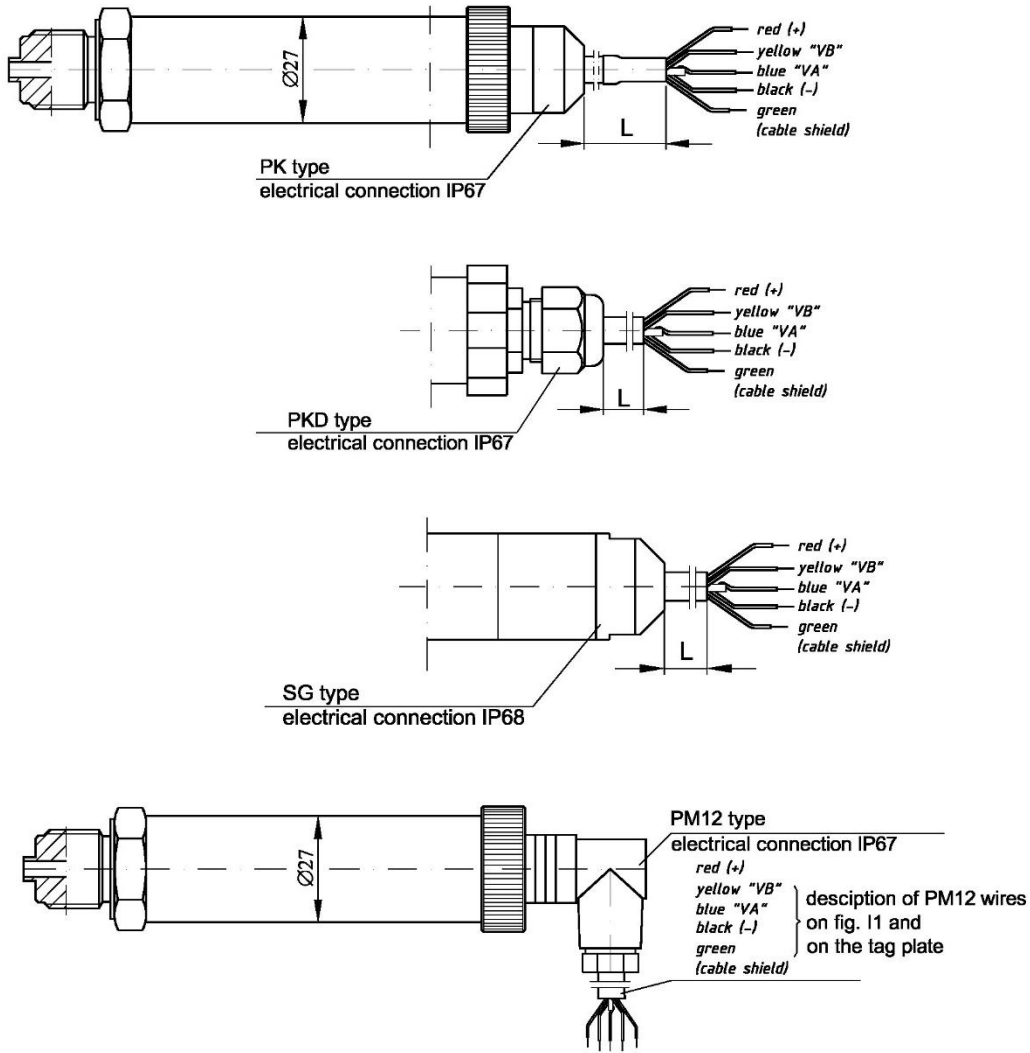

Fig. PK, PKD, SG and PM12 type connection.

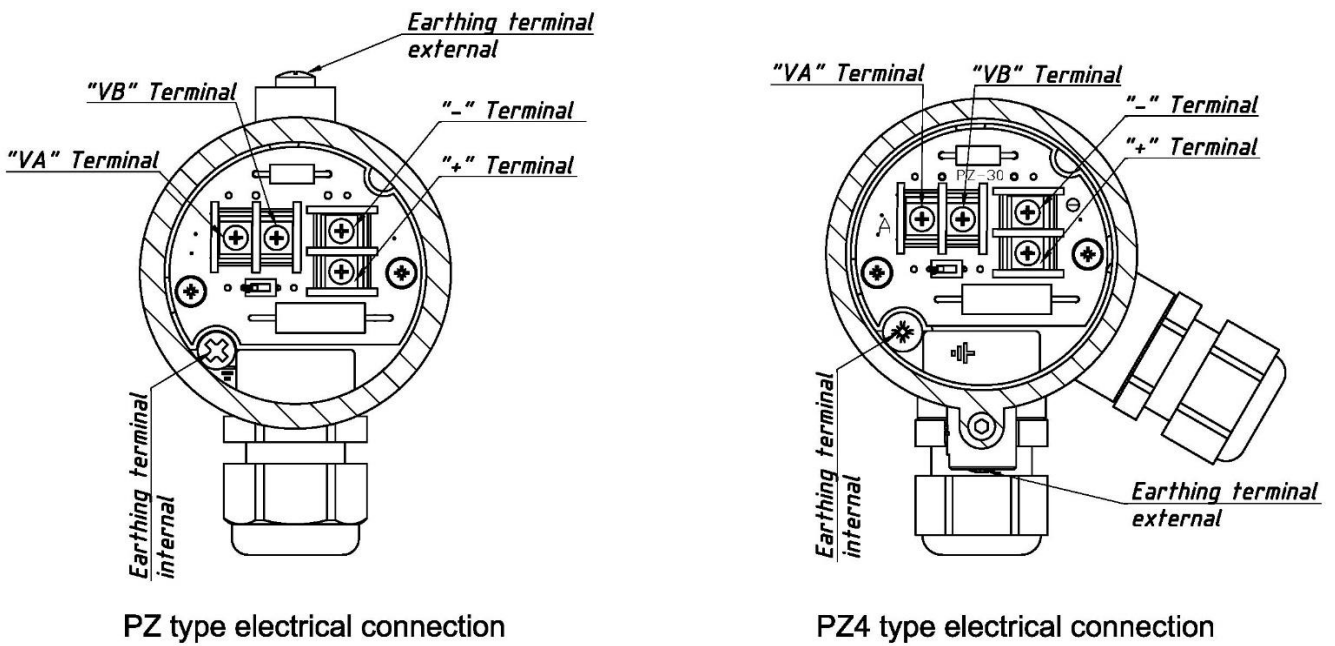

Fig. Type of PZ, PZ4 electrical connection.

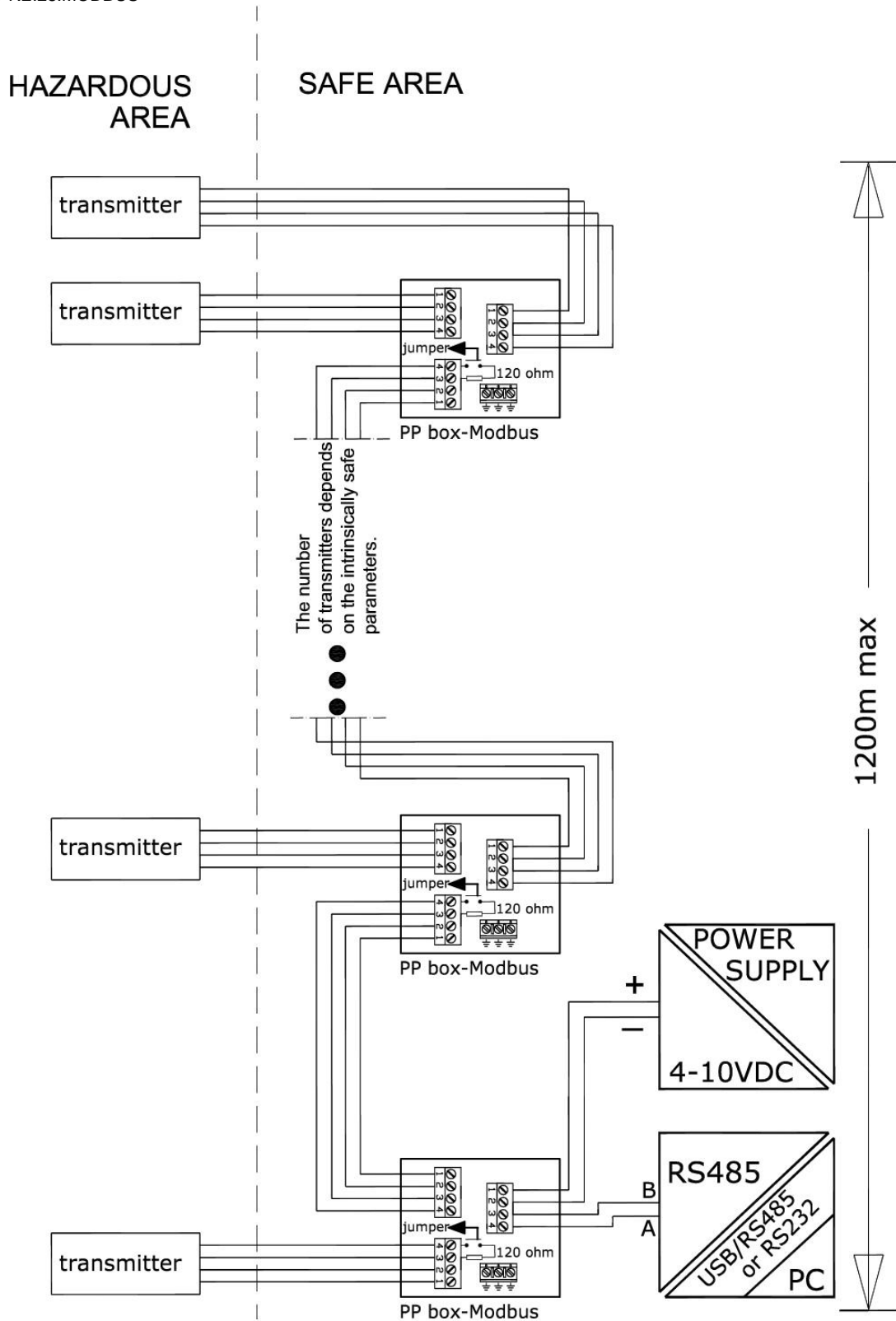

Fig. Diagram of connecting the transmitters in the Modbus network in Exi version.

The PCE-28.Modbus16, PRE-28.Modbus16 transmitter with PZ, PZ4 type electrical connection has a 560Ω resistor, which can be used as a line/bus terminator. Switching on the resistor can be done using the DIP 1-position switch by switching to the ON position. The number of connectable transmitters with PZ, PZ4 electrical connection to the RS485 bus depends on the intrinsically safe parameters. In the case of a transmitter with a PZ4 connection, not more than 10 pcs.

5. Special conditions for safe use

1. The transmitters do not meet the insulation test (500 V rms) required by EN 60079 11:2012. This must be taken into account during installation of the device.
2. For the ambient temperature range, see →[Table Z1](#) as well as the information on the transmitters rating plate.
3. The process (medium) temperature at the diaphragm must be within the ambient temperature range.
4. If titanium parts are used in the separator design, the separator should be protected against mechanical impact during installation and operation of the transmitter.
5. Transmitters with a PTFE coated diaphragm seals, for the III Group, should be installed in places and in a way that prevents electrostatic charging.