

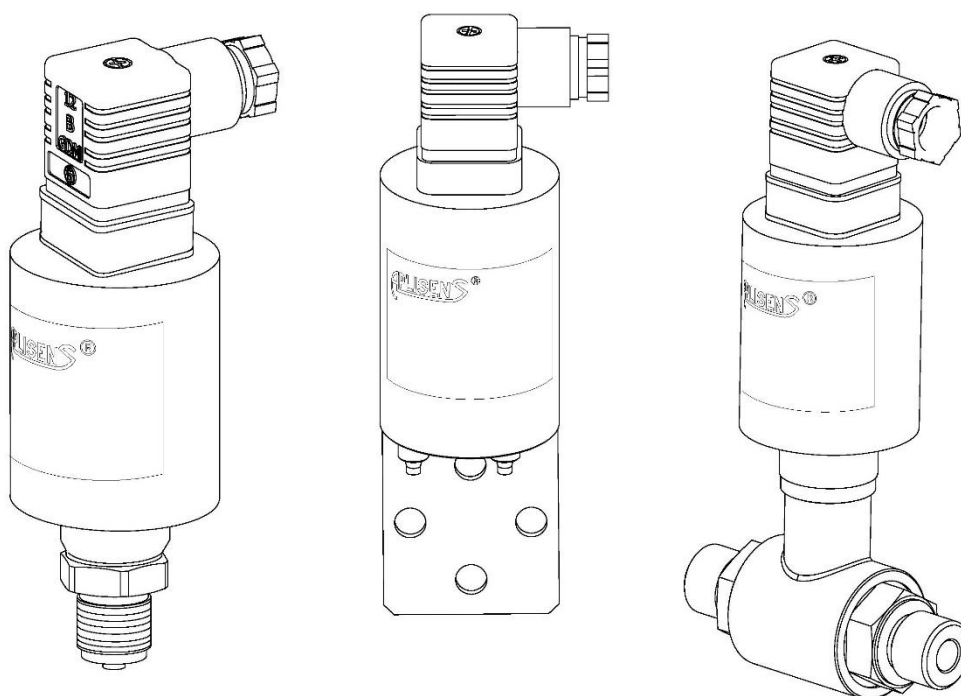

USER'S MANUAL

PRESSURE TRANSMITTERS **PC-50**

DIFFERENTIAL PRESSURE TRANSMITTERS **PR-50, PR-54, PRE-50G**



PRODUCT CODE – see: (→ [Transmitter identification](#)).

The QR code or ID number identifies the transmitter and provides quick access to the following documentation on the manufacturer's website: user's manual, declarations of conformity and copies of certificates.

PC-50

ID: 0049 0001 0000 0000 0000 0000 0001 87

<https://www.aplisens.pl/ID/004900010000000000000000000187/>



PR-50

ID: 0052 0001 0000 0000 0000 0000 0001 78

<https://www.aplisens.pl/ID/005200010000000000000000000178/>



PRE-50G

ID: 0051 0001 0000 0000 0000 0000 0001 81

<https://www.aplisens.pl/ID/005100010000000000000000000181/>





PR-54

ID: 0053 0001 0000 0000 0000 0000 0001 75

<https://www.aplisens.pl/ID/005300010000000000000000000175/>



Symbols used

Symbol	Description
	Warning to proceed strictly in accordance with the information contained in the documentation in order to ensure the safety and full functionality of the device.
	Information particularly useful during installation and operation of the device.
	Information on disposal of used equipment.

BASIC REQUIREMENTS AND SAFE USE



The manufacturer will not be liable for damage resulting from incorrect installation, failure to maintain a suitable technical condition of the device or use of the device other than for its intended purpose.

Installation should be carried out by qualified staff having the required authorizations to install electrical and I&C equipment. The installer is responsible for performing the installation in accordance with manual as well as with the electromagnetic compatibility and safety regulations and standards applicable to the type of installation.

In systems with I&C equipment, in case of leakage, there is a danger to staff due to the medium under pressure. All safety and protection requirements must be observed during installation, operation and inspections.

If a malfunction occurs, the device should be disconnected and handed over to the manufacturer for repair.



In order to minimize the risk of malfunction and associated risks to staff, the device is not to be installed or used in particularly unfavourable conditions, where the following hazards occur:

- possible mechanical impacts, excessive shocks and vibration;
- excessive temperature fluctuation;
- water vapour condensation, dusting, icing.

Changes made to the manufacturing of products may be introduced before the paper version of the manual is updated. The up-to-date manuals are available on the manufacturer's website: www.aplisens.com.

TABLE OF CONTENTS

1. INTRODUCTION	5
1.1. Purpose of the document	5
2. SAFETY	5
3. TRANSPORT AND STORAGE	6
3.1. Delivery check.....	6
3.2. Transport.....	6
3.3. Storage.....	6
4. GUARANTEE	6
5. IDENTIFICATION	7
5.1. Manufacturer's address.....	7
5.2. Transmitter identification	7
5.3. CE mark, declaration of conformity	7
6. INSTALLATION	8
6.1. General recommendations	8
6.1.1. Installation instructions for transmitters with separators	8
7. ELECTRICAL CONNECTION	9
7.1. Cable connection to transmitter.....	9
7.1.1. Connection of transmitters with PD-type connector	9
7.1.2. Cabling specification	9
7.1.3. Grounding	10
7.1.4. Overvoltage protection	10
7.1.5. Shielding, equipotential bonding	10
7.2. Transmitter power supply	11
7.2.1. Transmitter supply voltage	11
7.2.2. Resistance load in power supply line	11
7.3. Final inspection of cabling.....	11
8. START-UP	12
8.1. Correction of impact of transmitter mounting position after installation	12
9. MAINTENANCE	13
9.1. Periodic inspections	13
9.2. Non-periodic inspections	13
9.3. Cleaning/washing.....	13
9.3.1. Diaphragm cleaning	13
9.4. Spare parts.....	13
9.5. Repair	13
9.6. Returns.....	13
10. SCRAPPING, DISPOSAL	14
11. HISTORY OF REVISIONS	14

LIST OF DRAWINGS

Figure 1. Electrical connection of the transmitter.	9
---	---

LIST OF TABLES

Table 1. Symbols appearing on the transmitter's nameplate.....	7
Table 2. Permissible transmitter supply voltages.	11

1. INTRODUCTION

1.1. Purpose of the document

The subject of manual are pressure transmitters **PC-50**, and differential pressure transmitters **PR-50, PR-54, PRE-50G**. The manual applies to the standard versions.

The manual contains data, tips and general recommendations for safe installation and operation of the transmitters, as well as troubleshooting in case of possible failure.

2. SAFETY



- The installation and start-up of the device and any activities related to operation shall be carried out after thorough examination of the contents of user's manual and the instructions related thereto;
- installation and maintenance should be carried out by qualified staff having the required authorizations to install electrical and measuring devices;
- the device shall be used according to its intended purpose in line with the permissible parameters specified on the nameplate (→ [Transmitter identification](#));
- the protection elements used by the manufacturer to ensure transmitter safety may be less effective if the device is operated in a manner not consistent with its intended purpose;
- before installing or disassembling the device, it is absolutely necessary to disconnect it from the power source;
- no repairs or alterations to the transmitter electronic system are permitted. Assessment of damages and possible repair may only be performed by the manufacturer or authorized representative;
- do not use instruments if damaged. In case of malfunction, the device must be put out of operation;
- in case of transmitters equipped with factory-mounted process connector of C type, it is unacceptable to loosen the fixing screws of the connector cover.

3. TRANSPORT AND STORAGE

3.1. Delivery check

After receiving the delivery of the equipment, please refer to the general terms and conditions available on the manufacturer's website: https://aplisens.com/ogolne_warunki_umow.html.

3.2. Transport

Transport of transmitters shall be carried out with the use of covered means of transport, in original packages with diaphragm provided with protection. The packaging shall be protected against movement and direct impact of atmospheric factors.

3.3. Storage

Transmitters shall be stored in a factory packaging, in a room without vapours and aggressive substances, protected against mechanical impact.

Allowable ambient and operating temperature range:

PC-50: -40...80°C (-40...176°F);
PR-50, PR-54, PRE-50G: -25...80°C (-13...176°F).

4. GUARANTEE

General terms and conditions of guarantee are available on the manufacturer's website: www.aplisens.com/ogolne_warunki_gwarancji



The guarantee shall be repealed if the device is used against its intended use, failure to comply with user's manual or interference with the structure of the device.

5. IDENTIFICATION









5.1. Manufacturer's address

APLISENS S.A.
03-192 Warsaw
Morelowa 7 St.
Poland

5.2. Transmitter identification

Depending on the version of the transmitter, the nameplates may differ in the amount of information and parameters.

Table 1. Symbols appearing on the transmitter's nameplate.

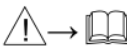
	Logo and name of manufacturer
	CE mark
	Product QR code
TYPE:	Transmitter type, type of electrical and process connector
ID	Transmitter model ID
# S/N	Transmitter serial number
 P	Measuring range
 U	Supply voltage values
	Output signal
 T _{amb}	Permissible range of ambient temperature
 PS	Maximum static pressure
IP	IP protection rating
Year of production	Year of production
	Note about the obligation to read the manual
//Lower part of the nameplate//	Special executions

5.3. CE mark, declaration of conformity

The device has been designed to meet the highest safety standards, has been tested and has left the factory in a condition that is safe for operation. The device complies with the applicable standards and regulations listed in the EU Declaration of Conformity and has CE marking on nameplate.

6. INSTALLATION

6.1. General recommendations



It is recommended that in case of a gaseous medium, the transmitters should be installed above the measuring point so that condensate may flow to the point from which the measured pressure is collected, while in case of liquid medium or steam, it should be installed below the point of pressure intake. The configuration of impulse tubes and valve connection system should be selected taking into account the measurement conditions.

Differential pressure transmitters for gases PRE-50G should be obligatorily installed vertically.

6.1.1. Installation instructions for transmitters with separators

The protection of the separator diaphragm can only be removed shortly before installation. Hydrostatic pressure of the manometric liquid column in the transmitter-separator system may cause incorrect indication of the measured value. After installation, the transmitter must be pressure-reset. Do not clean or touch separator diaphragms using hard or pointy objects.

Separators with pressure transmitter form a closed, calibrated system filled with gauge fluid. The opening for filling the device with gauge fluid is sealed and must not be opened.



When choosing a mounting location, it is necessary to ensure sufficient stress relief of the capillaries tension in order to avoid excessive bending.

Incorrect installation of the sealing may result in incorrect measurement indications.

Special attention must be paid when selecting correct dimensions of the sealing.



As standard, the separators are not provided with the gaskets.

7. ELECTRICAL CONNECTION

7.1. Cable connection to transmitter



All connection and installation operations shall be performed with disconnected supply voltage and other external voltages, if used.



Failure to provide proper connection of the transmitter may result in danger. Risk of electric shock and/or ignition in potentially explosive atmospheres.

7.1.1. Connection of transmitters with PD-type connector

In order to properly connect the wires, remove the terminal block with its cover from the contact pins and remove the block from the cover, undermining it with the end of the screwdriver inserted into the slot provided for this purpose. Connect the wires to the cube as shown in the picture below.

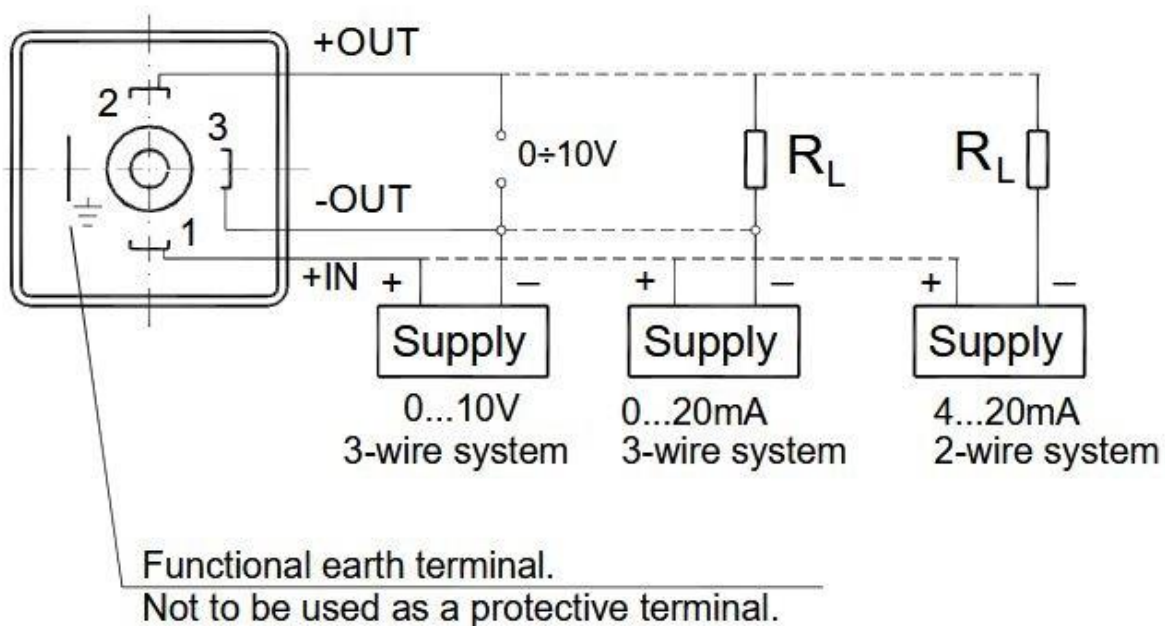

Figure 1. Electrical connection of the transmitter.



If the sealing of the cables in the gland is ineffective (e.g. when single cables are connected), the opening of the gland must be sealed with a flexible sealing compound to achieve IP54 protection. It is advantageous to form the section of the signal cable leading to the cable gland in the form of a drip loop in order to prevent condensation from running off towards the cable gland.

7.1.2. Cabling specification

Aplisens S.A. recommends using two-wire screened twisted pair cable. The recommended cable outer diameter is 8-10 mm (PG-11 gland).

7.1.3. Grounding

Transmitters with PD connections have a ground terminal in the connector which should not be used for protective earthing or connecting an equipotential bonding cable; it is only used for functional earthing. If the transmitter has, via the process connection, a galvanic connection to a well earthed metal pipeline or tank, additional functional earthing is not necessary. The earthing terminals in the electrical connections act as functional earthing. They should be used when the transmitter is not earthed through the head connection port. If there is no possibility of earthing the cable shield at the power supply point and the transmitter is earthed through the head connector, earthing terminals can be used to connect the cable shield. Functional earthing is to ensure correct operation of the transmitter's anti-interference unit. In standard installations, i.e. when the transmitter is earthed through the pipeline and a possible cable screen is connected to the transmitter's power supply and measurement installation, the functional earthing terminal should not be used.

7.1.4. Overvoltage protection

Type of transmitter and electrical connection	Protection between wires (TVS diodes) – nominal voltages	Protection between wires and earth and/or enclosures - type of protection - nominal voltages
PC-50, PR-50, PR-54 with PD connector 4...20 mA output 2-wire transmission	39 V DC	Gas surge arrester– 230 V DC
PC-50, PR-50, PR-54 with PD connector 0...10 V, 0...20 mA output 3-wire transmission	between "+" and "-" of power supply 39 V DC between "-" of power supply and output 39 V DC	
PRE-50G with PD connector, 4...20 mA output 2-wire transmission	39 V DC	
PRE-50G with PD connector, 0...10 V output 3-wire transmission	between "+" and "-" of power supply 39 V DC between "-" of power supply and output 39 V DC	
In addition, an external protective device can be used, e.g. UZ-2 system produced by APLISENS S.A. or others.		

7.1.5. Shielding, equipotential bonding

When using a cable in the screen, connect the screen on one side at the transmitter's power supply point.

7.2. Transmitter power supply

7.2.1. Transmitter supply voltage



**Power cables may be live.
There is a risk of electric shock and/or explosion.**

Table 2. Permissible transmitter supply voltages.

Transmitter	Output signal	Min. supply voltage	Max. supply voltage
PRE-50G PC-50	4...20 mA 2-wire transmission	10 V DC	36 V DC
	0...20 mA 3-wire transmission	10 V DC	36 V DC
PR-50 PR-54	0...10 V 3-wire transmission	13 V DC	39 V DC

7.2.2. Resistance load in power supply line

The power line resistance, power source resistance and other additional serial resistances increase the voltage drops between the power source and the transmitter terminals. The maximum current of transmitters under normal operation conditions is defined as 0,02 A.

The maximum resistance value in the power circuit (along with the power cables resistance) is defined by the formula:

$$R_{L_MAX} = \frac{(U_{SPLY} - U_{MIN})[V]}{0,02 [A]} \quad (\text{for } 4...20 \text{ mA output})$$

$$R_{L_MAX} \geq 20 \text{ k}\Omega \quad (\text{for voltage output})$$

where:

U_{SPLY} – voltage at the supply terminals of the 4...20 mA current loop [V].

U_{MIN} – minimum supply voltage of transmitter → [Table 2. Permissible transmitter supply voltages.](#)

R_{L_MAX} – maximum power supply line resistance [Ω].

7.3. Final inspection of cabling

After completing the electrical installation of the transmitter it is necessary to check the following:

- Does the supply voltage measured at the transmitter terminals at maximum set current match the range of supply voltage specified on the transmitter nameplate?
- Is the transmitter connected according to the information given in section (→ [Cable connection to transmitter](#))?
- Are all the screws tightened?
- Is the cable gland tightened?

8. START-UP

The base range of the transmitter can be read out from its nameplate (→ [Transmitter identification](#)).



Use the transmitter within the allowable pressure limits. Risk of injury due to component breakage after exceeding the maximum permitted operating pressure.

8.1. Correction of impact of transmitter mounting position after installation

After installation of the transmitter, it may be necessary to adjust the zero signal (mainly for low pressure ranges and versions with separators). This can be done using a precision screwdriver and a millimeter, or a millivoltmeter for a relative pressure (gauge) transmitter with zero set for atmospheric pressure. The adjustment can be made after the transducer has been supplied with electricity, the electrical connection has been partially disassembled, and the appropriate potentiometer labelled 'zero' is accessible. At atmospheric pressure in the system, the potentiometer should be used to reduce the zero signal to its initial value: 4 mA, 0 mA or 0 V depending on the output signal.

At initial pressures other than zero, zero adjustment can only be carried out when the pressure at the lower limit of the measuring range is delivered to the transmitter input. The zero signal can be adjusted or shifted up to 10% of the measuring range width (FSO) from the factory set value.

9. MAINTENANCE

9.1. Periodic inspections

Periodic inspections shall be carried out in accordance with applicable standards. During the inspection, the condition of the pressure (absence of loosened elements and leaks) and electrical (check of connections reliability and condition of gaskets and glands) connectors, condition of separating diaphragms (tarnish, corrosion) and stability of fixing of the housing and mounting bracket (if used) shall be checked.

9.2. Non-periodic inspections

If the transmitter at the installation site has been exposed to mechanical damage, pressure overload, hydraulic pulses, overvoltage, deposits, medium crystallization, undercutting of the diaphragm, or incorrect operation of the transmitter is detected, the device should be inspected. Check the condition of the diaphragm, clean it, check the electrical functionality of the transmitter and the processing characteristics.



If there is no signal in the transmission line or its value is improper, check the supply line, connection status on terminal blocks, connectors, etc. Check if the supply voltage and load resistance are correct.

9.3. Cleaning/washing

To remove impurities from the external surfaces of the transmitter wipe it with a cloth dampened in water.

9.3.1. Diaphragm cleaning

The only possible method of cleaning the transmitter diaphragms is to dissolve the sludge produced.



Do not remove deposits and impurities from the transmitter diaphragms, which are formed during operation, mechanically using tools, since the diaphragms and the transmitter can be damaged.

9.4. Spare parts

Parts of the transmitter that may be worn or damaged and thus replaced in PD connector: terminal block with angle cover and seal and connector base with seal.

9.5. Repair

Faulty or non-operational transmitter shall be provided to the manufacturer.

9.6. Returns

In the following cases, the transmitter should be returned directly to the manufacturer:

- need for repair;
- need for factory calibration;
- replacement of improperly selected/shipped transmitter.

10. SCRAPPING, DISPOSAL



Worn or damaged devices shall be scrapped in accordance with WEEE Directive (2012/19/EU) on waste electrical and electronic equipment or returned to the manufacturer.

11. HISTORY OF REVISIONS

Revision No.	Document revision	Description of changes
-	DTR.PRE-50G(ENG)/07.2012	-
1	DTR.PRE-50G(ENG) Revision A/03.2014	Editorial changes.
2	DTR.PR-54(ENG)/03.2016	-
3	01.A.001/2022.03	New document edition. Change of electronics, update of supply voltage. Developed by DBFD.

