

APLISENS

**MANUFACTURE OF PRESSURE TRANSMITTERS
AND CONTROL INSTRUMENTS**

USER'S MANUAL

PRESSURE TRANSMITTERS

type PC-29A, PC-29B – Exi - version

PC-29 – normal - version

DIFFERENTIAL PRESSURE TRANSMITTERS

type PR-29A, PR-29B – Exi - version

PR-29 – normal - version

HYDROSTATIC LEVEL PROBES

type PC-29PA, PC-29PB – Exi - version

PC-29P – normal - version

HYDROSTATIC LEVEL PROBES





type SG-25A, SG-25B – Exi - version

SG-25 – normal - version

Edition 01.A.001./06.16

WARSAW JUNE 2016

Symbols used

Symbol	Description
	Warning to proceed strictly in accordance with the information contained in the documentation in order to ensure the safety and full functionality of the device.
	Information particularly useful during installation and operation of the device.
	Information particularly useful during installation and operation of a type Exi device.
	Pressure transmitters should be scrapped and utilized in accordance with the WEEE Directive (2002/96 /WE) in matter of used electric and electronic equipment

BASIC REQUIREMENTS AND SAFE USE



- **The manufacturer will not be liable for damage resulting from incorrect installation, failure to maintain the device in a suitable technical condition, or use of the device other than for its intended purpose.**
- Installation should be carried out by qualified staff having the required authorizations to install electrical and pressure-measuring devices. The installer is responsible for performing the installation in accordance with these instructions and with the electromagnetic compatibility and safety regulations and standards applicable to the type of installation.
- Installation should be carried out by qualified staff having the required authorizations to install electrical and pressure-measuring devices. The installer is responsible for performing the installation in accordance with these instructions and with the electromagnetic compatibility and safety regulations and standards applicable to the type of installation.
- If a device is not functioning correctly, disconnect it and send it for repair to the manufacturer or to a firm authorized by the manufacturer.



In order to minimize the risk of malfunction and associated risks to staff, the device is not to be installed or used in particularly unfavourable conditions, where the following dangers occur:

- possibility of mechanical impacts, excessive shocks and vibration;
- excessive temperature fluctuation, exposure to direct sunlight;
- condensation of water vapour, dust, icing.



Installation of intrinsic safety versions should be performed with particular care, in accordance with the regulations and standards applicable to that type of installation.

Changes to the products manufacturing documentation may forestall a paper user updating. Current User Manual is available at www.aplisens.pl

CONTENTS

I. APPENDIX Exi.ATEX	3
II. APPENDIX Exi. IECEx	7
1. INTRODUCTION	10
2. USER MATERIALS	10
3. APPLICATIONS AND MAIN FEATURES	10
4. IDENTIFYING MARKS	11
5. TECHNICAL DATA	11
5.1. Measurement ranges and metrological parameters	11
5.2. Electrical parameters	12
5.3. Permitted Environmental Conditions	12
5.4. Construction materials	13
5.5. Pressure connectors	13
6. CONSTRUCTION. ELECTRICAL CONNECTIONS	13
6.1. Measurement Principles	13
6.2. Construction	13
6.3. Casing, Electrical Connections	14
7. PLACE OF INSTALLATION OF TRANSMITTERS	14
7.1. General note	14
7.2. Low Ambient Temperature	14
7.3. High Medium Temperature	15
7.4. Mechanical Vibration, Corrosive Media	15
8. INSTALLATION AND MECHANICAL CONNECTIONS	15
9. ELECTRICAL CONNECTION	16
9.1. General recommendations	16
9.2. Connections for transmitters with PD-type connector	16
9.3. Connections for transmitters with PK, PKD, SG, SGM -type connector	16
9.4. Connections for transmitters with terminal box (PZ-type connector)	16
9.5. Protection from excess voltage	16
9.6. Earthing	16
10. SETTING OF ZERO POSITION AND MEASUREMENT RANGE	17
11. SERVICES AND SPARE PARTS	17
11.1. Periodic service	17
11.2. Unscheduled services	17
11.3. Cleaning the Diaphragm Seal, Overloading Damage	17
11.4. Spare parts	17
12. PC-29P, PC-29PA, PC-29PB LEVEL PROBES	18
12.1. Application	18
12.2. Technical Data	18
12.3. Principles of Operation. Construction	18
12.4. Place and method of installation. Fitting	18
12.5. Electrical connection. Settings	18
13. HYDROSTATIC LEVEL PROBES SG-25, SG-25A, SG-25B	19
13.1. Applications	19
13.3. Principles of Operation. Construction	19
13.4. SG-25, SG-25A, SG-25B. Place of installation	20
13.5. Electrical Connection. Settings	20
14. PACKING, STORAGE AND TRANSPORT	20
15. GUARANTEE	20
17. ADDITIONAL INFORMATION	21
17.1. Related documents	21
17.2. Related standards	21
18. FIGURES	21
Fig.1. PC-29, PC-29A, PC-29B transmitters with PD, PK, PKD, SG, SGM connectors: dimensions and methods of connection	22
Fig.2. PC-29, PC-29A, PC-29B transmitters with PZ. Dimensions	23
Fig.3. M-type connector with M20x1.5 thread	24
Fig.4. P-type connector with M20x1.5 thread	24
Fig.5. CM30x2-type connector with flush diaphragm with M30x2 thread	24
Fig.6. Process connections G1/2" and G	25
Fig.7. PR-29, PR-29A, PR-29B differential pressure transmitter with PD, PK connectors Dimensions	26

Fig.8. PR-29, PR-29A, PR-29B differential pressure transmitter with C-type process connection to be mounted together with valve manifold.....	27
Fig.9. PC-29P, PC-29PA, PC-29PB level probes.....	27
Fig.10. Example: how to install the PR-29, PR-29A, PR-29B differential pressure transmitter	28
Fig.11. Example: how to install the PR-29, PR-29A, PR-29B transmitter on a vertical or horizontal pipe.	29
Fig.12. Example: how to install the PR-29, PR-29A, PR-29B transmitter with a valve manifold to a wall	29
Fig.13. Possible methods of isolating the transmitter from high temperatures	30
Fig.14. SG-25, SG-25A, SG-25B probes. Dimensions	31
Fig.15. Wiring diagram SG-25, SG-25A, SG-25B probes.	31

I. APPENDIX Exi.ATEX



PC-29A/XX/YY, PC-29B/XX/YY – PRESSURE TRANSMITTERS,
 PC-29PA/YY, PC-29PB/YY – TRANSMITTERS – LEVEL PROBES
 PR-29A/XX/YY, PR-29B/XX/YY – DIFFERENTIAL PRESSURE TRANSMITTERS
 SG-25A, SG-25B - LEVEL PROBES
 Exi VERSIONS according to ATEX

1. Introduction

1.1. The „Appendix Exi.ATEX” to IO.PC.PR-29.03(ENG) applies to PC-29A/XX/YY, PC-29B/XX/YY, PC-29PA/YY, PC-29PB/YY, PR-29A/XX/YY, PR-29B/XX/YY transmitters and SG-25A, SG-25B level probes in Exi version according to ATEX, marked on the rating plate as shown in 2.2. and signed “Exi” in the Product Certificate, only.

1.2. The appendix contains supplementary information relating to the Exi version transmitters and probes. During installation and use of the Exi transmitters, reference should be made to IO.PC.PR-29.03(ENG) in conjunction with “Appendix Exi.ATEX”.

2. Using of transmitters showed in point 1 in danger zones

2.1. Above transmitters are produced in accordance with the requirements of the following standards:
 EN 60079-0:2012 + A11:2013, EN 60079-11:2012, EN 50303:2000

2.2. The PC-29A, PC-29B, PR-29A, PR-29B PC-29PA, PC-29PB transmitters may operate in areas where there is a risk of explosion, in accordance with the rating of the explosion protection design:



II 1/2G Ex ia IIC T4/T5/T6 Ga/Gb
 I M1 Ex ia I Ma
 FTZU 10 ATEX 0295X

2.3. The transmitters with PKD electrical connector are permitted only for potentially explosive gas atmospheres and are marked:



II 1/2G Ex ia IIC T4/T5/T6 Ga/Gb
 FTZU 10 ATEX 0295X

2.4. The SG-25A, SG-25B probes may operate in areas where there is a risk of explosion, in accordance with the rating of the explosion protection design:



II 1G Ex ia IIB T4/T5/T6 Ga
 I M1 Ex ia I Ma
 FTZU 10 ATEX 0295X

3. Identifying marks.

Intrinsically safe transmitters and probes (Exi version) must have a rating plate containing the information specified in paragraph 4 of IO.PC.PR-29.03(ENG) and also at least the following:

- CE mark and the notified unit number: 1453, mark 
- designation of explosion protection design, certificate number
- values of parameters such as: Ui, li, Ci, Li
- manufacture year and serial number.,

4. Consignment contents

Together with the transmitter are delivered:

- a) „Product certificate, which is also as the warranty card
- b) Declaration of Conformity,
- c) Certificate copy– on request
- d) „User’s Manual signed „IO.PC.PR-29.03(ENG)”.

Items b), c), d) are available at www.aplisens.pl



5. Permissible input parameters

The transmitters should be powered via the power supplier and measurement devices provided with the relevant intrinsic-safe certificates. The parameters of their outputs to the danger zone should not exceed the limit power supply parameters specified below for the transmitters:



Output signal of Exi power supply in case of short-circuit should be smaller than 0.2A.

5.1. Power supply PC-29A, PC-29PA, PR-29A, SG-25A

- for circuit of power supply - terminals 1 – 3 or red and black wires - for SG-25A

Power supply with a "linear" characteristic: $U_i = 16V$ DC, $I_i = 0,2A$, $P_i = 0,8W$,

Power supply with a "trapezoidal" and "rectangular" characteristic: $U_i = 16V$ DC, $I_i = 0,05A$, $P_i = 0,6W$,

$40^\circ C \leq T_a \leq 80^\circ C$ and T4; $-40^\circ C \leq T_a \leq 70^\circ C$ and T5; dla $-40^\circ C \leq T_a \leq 45^\circ C$ and T6, $C_i = 10nF$, $L_i = 10\mu H$

for circuit of output signal – terminals 2 - 3: or blue and black wires - for SG-25A

$U_o = U_i$, $I_o = I_i$, $P_o = P_i$

$L_o = 0.55mH$, $C_o = 0.3\mu F$

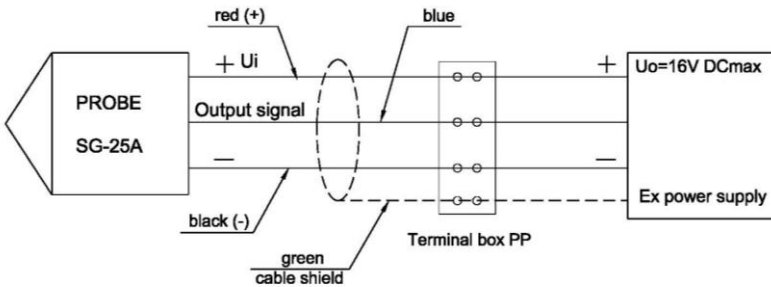
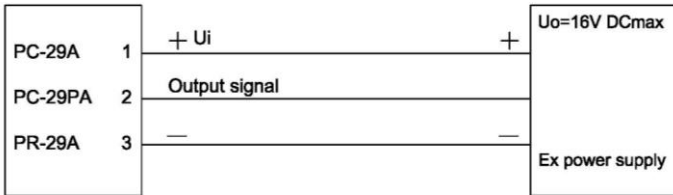

Fig.1. Power supply PC-29A, PC-29PA, PR-29A, SG-25A with a "linear" characteristic - example.

5.2. Power supply PC-29B, PC-29PB, PR-29B, SG-25B

- for circuit of power supply - terminals 1 - 3: or red and black wires - for SG-25B

$$U_i = 5,6V \text{ DC}, I_i = 0,2A, P_i = 0,56W,$$

for $-40^\circ\text{C} \leq T_a \leq 80^\circ\text{C}$ and T4, for $-40^\circ\text{C} \leq T_a \leq 70^\circ\text{C}$ and T5, for $-40^\circ\text{C} \leq T_a \leq 45^\circ\text{C}$ and T6

$$C_i = 10\mu\text{F}, \quad L_i = 10\mu\text{H}$$

- for circuit of output signal – terminals 2 - 3: or blue and black wires - for SG-25B

$$U_o = 5.6V\text{DC} \quad I_o = 0.2A, \quad P_o = 0.56W$$

$$L_o = 0.55\text{mH}, \quad C_o = 40\mu\text{F}$$

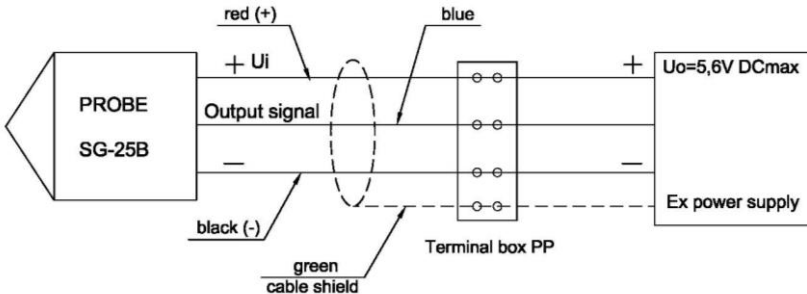
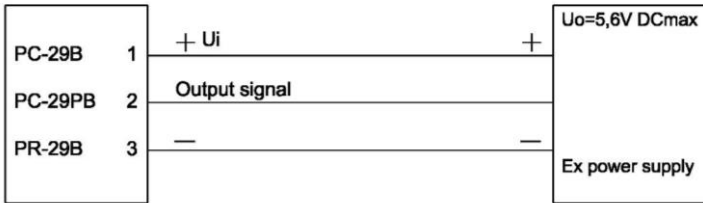

Fig.2. Power supply PC-29B, PC-29PB, PR-29B, SG-25B with a "linear" characteristic - example.

5.3. Special conditions for safe use:

Ambient temperature range:

$-40^\circ\text{C} \leq T_a \leq 80^\circ\text{C}$ for temperature class T4

$-40^\circ\text{C} \leq T_a \leq 70^\circ\text{C}$ for temperature class T5

$-40^\circ\text{C} \leq T_a \leq 45^\circ\text{C}$ for temperature class T6

Version of the transmitter with surge arrester, marked on the plate "SA", does not meet the requirements of section 6.3.13 of EN 60079-1 1 :2012 (test of isolation 500 VAC). This must be taken into account during the installation of transmitters,

6. How to connect Exi transmitters.

The transmitter and other devices in the measuring loop should be connected in accordance with the intrinsic-safety and explosion-safety regulations and the conditions for use in dangerous areas.

Failure to observe the intrinsic-safety regulations can cause explosion and the resulting hazard to people.

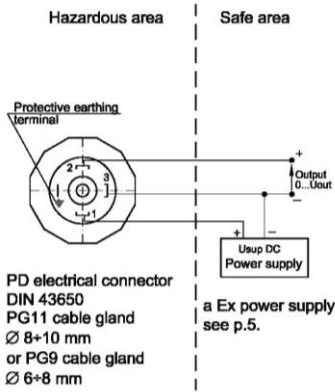

Fig.3a

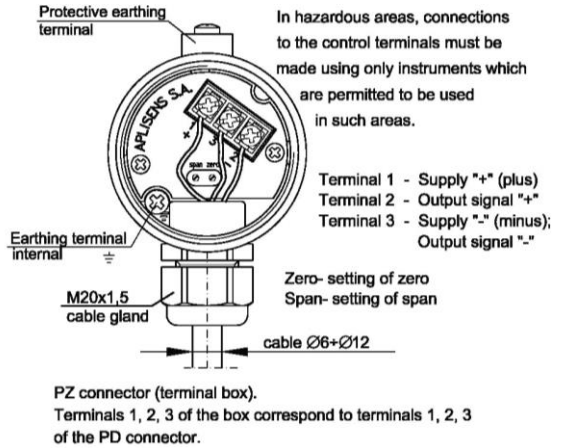

Fig.3b

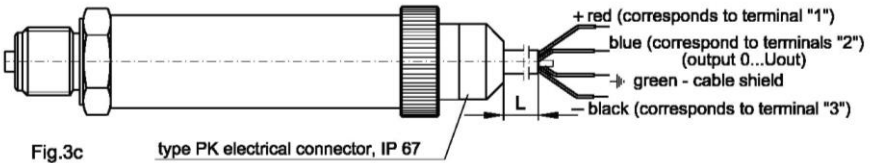

Fig.3c

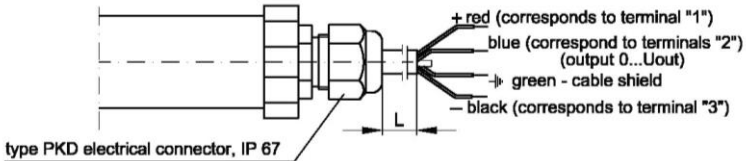

Fig.3d

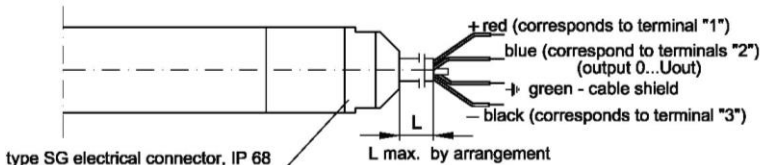

Fig.3e

Fig.3

PD and PZ connectors are connected as above; the PK, PKD connector is connected as shown in Fig.1 in IO.PC.PR-29.03(ENG) page 14.



It is not allowed to repair or otherwise interfere with the transmitter's electrical circuits in any way.
Damage and possible repair can be assessed and done by the manufactures or another authorized party only

II. APPENDIX Exi. IECEX

PC-29A/XX/YY, PC-29B/XX/YY – PRESSURE TRANSMITTER,
 PC-29PA/YY, PC-29PB/YY – TRANSMITTER – LEVEL PROBE
 PR-29A/XX/YY, PR-29B/XX/YY – DIFFERENTIAL PRESSURE TRANSMITTER
 SG-25A, SG-25B - LEVEL PROBES
 Exi VERSIONS according to IECEX

1. Introduction

1.1. The „Appendix Exi.IECEX” to IO.PC.PR-29.03(ENG) applies to PC-29A/XX/YY, PC-29B/XX/YY, PC-29PA/YY, PC-29PB/YY and PR-29A/XX/YY, PR-29B/XX/YY transmitters and SG-25A, SG-25B level probes in Exi version according to IECEX, marked on the rating plate as shown in 2.2. and signed “Exi” in the Product Certificate, only.

1.2. The appendix contains supplementary information relating to the Exi version transmitters. During installation and use of the Exi transmitters, reference should be made to IO.PC.PR-29.03(ENG) in conjunction with “Appendix Exi.IECEX”.

2. Using of transmitters showed in point 1 in danger zones

2.1. The transmitters are produced in accordance with the requirements of the following standards: IEC 60079-0:2007-10, IEC 60079-26:2006, IEC 60079-11:2006.

2.2. The PC-29A, PC-29B, PR-29A, PR-29B PC-29PA, PC-29PB transmitters may operate in areas where there is a risk of explosion, in accordance with the rating of the explosion protection design:

Ex ia IIC T4/T5/T6 Ga/Gb

Ex ia I Ma

IECEX FTZU 11.0004X

2.3. The transmitters with PKD electrical connector are permitted only for potentially explosive gas atmospheres and are marked:

Ex ia IIC T4/T5/T6 Ga/Gb

IECEX FTZU 11.0004X

2.4. The SG-25A, SG-25B probes may operate in areas where there is a risk of explosion, in accordance with the rating of the explosion protection design:

Ex ia IIB T4/T5/T6 Ga

Ex ia I Ma

IECEX FTZU 11.0004X

3. Identifying marks.

Intrinsically safe transmitters (Exi version) must have a rating plate containing the information specified in paragraph 4 of IO.PC.PR-29.03(ENG) and also at least the following:

- designation of explosion protection design, certificate number
- values of parameters such as: Ui, li, Ci, Li
- manufacture year and serial number.,

4. Consignment contents

Together with the transmitter are delivered:

- a) „Product certificate, which is also as the warranty card
- b) Declaration of Conformity,
- c) Certificate copy– on request
- d) „User’s Manual signed „IO.PC.PR-29.03(ENG)”.

Items b), c), d) are available at www.aplisens.pl



5. Permissible input parameters



The transmitters should be powered via the power supplier and measurement devices provided with the relevant intrinsic-safe certificates. The parameters of their outputs to the danger zone should not exceed the limit power supply parameters specified below for the transmitters:

Output signal of Exi power supply in case of short-circuit should be smaller than 0.2A.
Power supply with a "linear" characteristic - example.

5.1. Power supply PC-29A, PC-29PA, PR-29A and group IIB

- for circuit of power supply - terminals 1 – 3 or red and black wires - for SG-25A
- Power supply with a "linear" characteristic: $U_i = 16V$ DC, $I_i = 0,2A$, $P_i = 0,8W$,
- Power supply with a "trapezoidal" and "rectangular" characteristic: $U_i = 16V$ DC, $I_i = 0,05A$, $P_i = 0,6W$,
- $40^\circ C \leq T_a \leq 80^\circ C$ and T4; $-40^\circ C \leq T_a \leq 70^\circ C$ and T5; dla $-40^\circ C \leq T_a \leq 45^\circ C$ and T6, $C_i = 10nF$, $L_i = 10\mu H$
- for circuit of output signal – terminals 2 - 3: or blue and black wires - for SG-25A
- $U_o = 16VDC$, $I_o = 0,2A$, $P_o = 0,8W$
- $L_o = 0,55mH$, $C_o = 0,3\mu F$

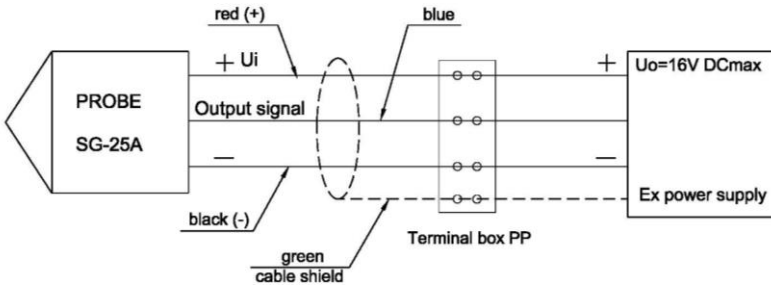
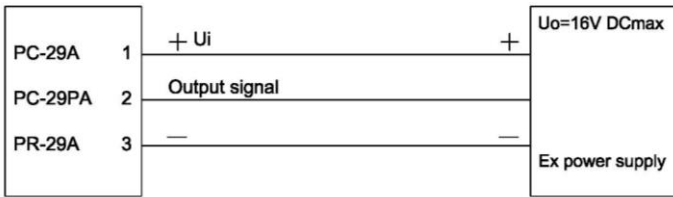

Fig.1. Power supply with a "linear" characteristic - example.

5.2. Power supply PC-29B, PC-29PB, PR-29B - group IIC

- for circuit of power supply - terminals 1 - 3: or red and black wires - for SG-25B

$U_i = 5,6V$ DC, $I_i = 0,2A$, $P_i = 0,56W$,

for $-40^{\circ}C \leq T_a \leq 80^{\circ}C$ and T4, for $-40^{\circ}C \leq T_a \leq 70^{\circ}C$ and T5, for $-40^{\circ}C \leq T_a \leq 45^{\circ}C$ and T6

$C_i = 10\mu F$, $L_i = 10\mu H$

- for circuit of output signal – terminals 2 - 3: or blue and black wires - for SG-25B

$U_o = 5.6VDC$ $I_o = 0.2A$, $P_o = 0.56W$

$L_o = 0.55mH$, $C_o = 40\mu F$

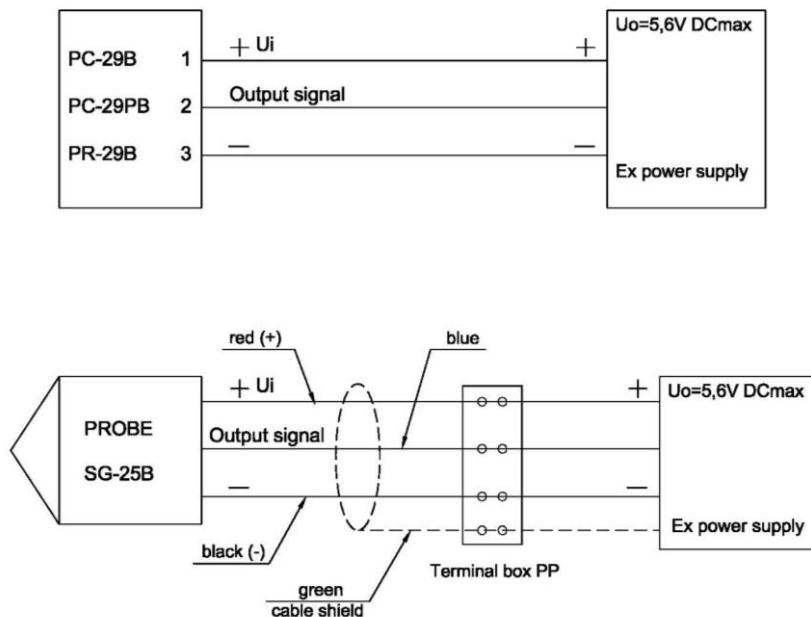

Fig.2. Power supply with a "linear" characteristic - example.

5.3. Special conditions for safe use:

- Ambient temperature range :

$-40^{\circ}C \leq T_a \leq 80^{\circ}C$ for temperature class T4,

$-40^{\circ}C \leq T_a \leq 70^{\circ}C$ for temperature class T5,

$-40^{\circ}C \leq T_a \leq 45^{\circ}C$ for temperature class T6.

- Version of the transmitter With surge arrester, marked on the plate "SA", does not meet the requirements of section 6.3.13 of EN 60079-11 (test of isolation 500 VAC). This must be taken into account during the installation of transmitters.

6. How to connect Exi transmitters: PC-29A/XX/YY, PC-29B/XX/YY, PC-29PA/YY, PC-29PB/YY, PR-29A/XX/YY, PR-29B/XX/YY, SG-25A, SG-25B

- acc. to p.6 IO.PC.PR-29.03(ENG). Appendix Exi.ATEX

1. INTRODUCTION

1.1. This user's manual is intended for electronic pressure transmitters users:

- a) pressure transmitters type: **PC-29, PC-29A, PC-29B**.
- b) transmitters – level probes type: **PC-29P, PC-29PA, PC-29PB**.
- c) differential pressure transmitters type: **PR-29, PR-29A, PR-29B**.
- d) level probes type: **SG-25A, SG-25B**

Above-mentioned transmitters due to the use and supply parameters can be divided into the following groups:

- pressure transmitters in standard version: **PC-29, PC-29P, PR-29**.
- level probes in standard version: **SG-25A, SG-25B**.
- pressure transmitters in Exi version: **PC-29, PC-29P, PR-29**.
- level probes in Exi version: **SG-25A, SG-25B**.

User's manual containing the data and guidelines necessary to understand the functioning of the transmitters and how to operate them.

1.2. The transmitters comply with the requirements of EU directives as shown on the plate and with the relevant Declaration of Conformity.

1.4. Data on **PC-29A, PC-29B, PR-29A, PR-29B** transmitters and **PC-29PA, PC-29PB** probes in Exi versions according to ATEX covered by the common EC-type test certificate **FTZÚ FTZU 10ATEX 0295X** are contained in the appendix designated: **IO.PC.PR-29.03(ENG). Appendix Exi.ATEX**.



During installation and use of transmitters and probes in Exi version, reference should be made to **IO.PC.PR-29.03(ENG)** in conjunction with **Appendix Exi.ATEX**.

1.5. Data on **PC-29A, PC-29B, PR-29A, PR-29B** transmitters and **PC-29PA, PC-29PB** probes in Exi versions according to IECEx covered by certificate **IECEx FTZU 11.0004X**. are contained in the appendix designated: **IO.PC.PR-29.03(ENG). Appendix Exi.IECEx**.



During installation and use of transmitters and probes in Exi version, reference should be made to **IO.PC.PR-29.03(ENG)** in conjunction with **Appendix Exi.IECEx**.

2. USER MATERIALS

Transmitters are delivered in single and/or multiple packs.

A transmitter is delivered together with a "Product Certificate" which is as a guarantee card also.

A batch of transmitters is supplied together with the User's Manual.

At the customer's request, a "Declaration of Compliance" and/or Certificate will be supplied.

(These documents are also published at the www.aplisens.pl).

3. APPLICATIONS AND MAIN FEATURES

3.1. The **PC-29, PC-29A, PC-29B** pressure transmitters are designed to measure gauge pressure, vacuum pressure and absolute pressure of gases, vapours and liquids (including corrosive).



3.2. The **PR-29, PR-29A, PR-29B** differential pressure transmitters are used to measure liquid levels in closed tanks, with static pressure of up to 25MPa or 32MPa for special version and to measure differential pressure at filters, orifices and others.

3.3. The **PC-29, PC-29A, PC-29B** and **PR-29, PR-29A, PR-29B** transmitters can be fitted with a range of additional process connectors, enabling them to be used in a conditions variety, such as dense media, reactive media, high and low temperature etc.

Data on these connectors can be found in the catalogue cards "DIAPHRAGM SEALS".

3.4. For depth measurements in open tanks, the transmitters are fitted with sensing modules with an extension tube, and are referred to as the **PC-29P, PC-29PA, PC-29PB level probes** fig.9 - (for details see Section 12).

3.5. The **SG-25A, SG-25B** probes are designed to measure the depth of liquid in wells, swimming pools, watercourses, boreholes etc (fig.14 - details, see p.13).

3.6. The transmitters and probes generate out details, see put voltage signal using three-wire transmission.

4. IDENTIFYING MARKS.

4.1. Every transmitter and probe carries a rating plate containing at least the following information: CE mark, manufacturer name, type, process connections, electrical connections, serial number, measurement range, output signal, power supply voltage.

4.2. **PC-29A, PC-29B, PR-29A, PR-29B** transmitters and **PC-29PA, PC-29PB** probes in Exi version, in accordance with the ATEX directive, have additional marks as described in **IO.PC.PR-29.03(ENG) Appendix Exi.ATEX** paragraph 3.

i

4.3. **PC-29A, PC-29B, PR-29A, PR-29B** transmitters and **PC-29PA, PC-29PB** probes in Exi version, in accordance with the IECEx directive, have additional marks as described in **IO.PC.PR-29.03(ENG) Appendix Exi.IECEx** paragraph 3

4.4. The designations to be used when ordering can be found in the Catalogue Cards.

5. TECHNICAL DATA

5.1. Measurement ranges and metrological parameters

5.1.1.PC-29, PC-29A, PC-29B. Measurement ranges and metrological parameters

The **PC-29, PC-29A, PC-29B** transmitters can be produced with any desired range in the interval:
0...10mbar÷0...1000bar (over pressure, under pressure)
400mbar ÷ 80bar (absolute pressure).

Recommended standard ranges:

over, under pressure (0÷ -1; -0,4; -0,1; 0,1; 0,4; 1; 2,5; 6; 10; 16; 25; 60; 160; 250; 400, 600, 1000) bar

absolute pressure (0 ÷ 0,4; 1; 2,5 6; 10; 16; 25; 60)bar

Table 1	Measurement range			
	25 mbar	100 mbar	400 mbar	0...1 bar ÷ 1000 bar
Overpressure limit (repeatable, no hysteresis)	1 bar	1 bar	2,5 bar	4 x range max 1200bar
Damaging overpressure	2 bar	2 bar	2,5 bar	8 x range max 2000 bar
Accuracy	0,6%	0,3%	0,2% (0,16 %-special version)	
Thermal error	typically 0,5%/10° C; max 0,6% / 10° C	typically 0,3% / 10° C; max 0,4% / 10° C		typically 0,2% /10° C; max 0,3% /10° C
Long term stability	0,6 % / year	0,2%/year	0,1 % / year	
Hysteresis and repeatability	0,05%			
Error due to supply voltage changes	0,005%/1V			
Thermal compensation range	-10÷80 °C			

5.1.2.PR-29, PR-29A, PR-29B. Measurement ranges and metrological parameters

The **PR-29, PR-29A, PR-29B** transmitters can be produced with any desired range in the interval
1,6mbar to 25 bar

Recommended ranges: (0,4; 1; 2,5; 6; 10; 16; 25)bar
(-0,1...0,1); (-1...1) bar

Table 2	Measurement range			
	100mbar	1bar	2bar	25bar
Static pressure limit Overpressure limit (repeatable, no hysteresis)	250bar (option 320 bar) (40bar for P-type connector)			
Accuracy	0,4%	0,25%		
Long term stability	0,2 % / year	0,1 % / year		
Thermal error / 10°C	typically - 0,3%, max - 0,4%	typically - 0,2%, max - 0,3%		
Zero shift error for static pressure *	0,1% / 10bar			

*- This error can be eliminated by zeroing the transmitter in static pressure conditions with zero differential pressure.

5.2. Electrical parameters

5.2.1. Power supply



Power supply of PC-29A, PC-29B, 29A PR-, PR-29B transmitters and PC-29PA, PC-29PB level probes in intrinsically safe versions must comply with the conditions according to „IO.PC.PR-29.03(ENG) Appendix Exi.ATEX” or “Appendix Exi.IECEx” , with the relationship between the value of supply voltage and the maximum value of the output signal according to the table below.

Type of transmitter / probe	Power supply	Permissible, maximum value of output signal
PC-29A, PC-29PA, PR-29A, SG-25A (Exi version)	- normal 12V DC - limiting 5,5 ÷ 14,1V DC	The real value of the power supply minus 3V DC
PC-29B, PC-29PB, PR-29B, SG-25B (Exi version)	- normal 4,5V DC - limiting 3,3 ÷ 5,6V DC	The real value of the power supply minus 1V DC

Power supply of transmitters and probes in non intrinsically safe versions

Type of transmitter / probe	Power supply	Permissible, maximum value of output signal
PC-29, PC-29P, PR-29	- normal 12V DC - limiting 3,3 ÷ 16V DC	The real value of the power supply minus 1V DC

Current consumption - about 2mA.

Error due to supply voltage change: 0,05%/1V

5.2.2. Output signals:

- typical: 0 ÷ 2V, 0 ÷ 2,5V, 0 ÷ 3,3V, 0,5 ÷ 4,5V, 0 ÷ 5V, 0 ÷ 10V.

- Another values of output signals by arrangement.

The limit values of the output signal may be in the range from -0.5 V DC to the max. value according to the 5.2.1 point.

5.2.3. Time constant:

Time constants in the standard: - for PC-29... - 20msek.
 - for PR-29... - 50msek.

Other values for the time constant on request.

5.2.4. Load resistance R [Ω] ≥ 20kΩ
Voltage for insulation strength testing 500 VAC or 750 VDC.
Excess voltage protection see p.9.5.

5.3. Permitted Environmental Conditions

Ambient temperature limit -40 ÷ 80°C,



(Operating temperature range for intrinsic-safe versions in accordance with Appendix Exi.ATEX or Appendix Exi.IECEx)

Process temperature limit -40 ÷ 120°C – for direct measurement,
 over 120°C, only with the use of a diaphragm seal
 radiator, looped siphon tube or impulse line
Relative humidity 0 ÷ 95%
Vibration during operation max 4g
Exposure to direct sunlight not recommended causing strong transmitter warming.

5.4. Construction materials

Diaphragm	Stainless steel 1.4435 (316L)
Sensing module	Stainless steel 1.4404 (316L)
Casing for electronic parts	Steel pipe, 1.4301 (304)
PZ-type terminal box	Thick steel pipe, 1.4301 (304)
Angular connector, DIN 43650, PD type	itamide
P-type connector	Stainless steel 1.4404 (316L)
C-type connector	Stainless steel 1.4404 (316L)
Liquid filling the interior of the sensing module	Silicone oil, chemically inactive liquid for measurement of oxygen.
Cable shield in PK connector	Polyurethane, special version – teflon

5.5. Pressure connectors

5.5.1. PC-29A, PC-29B. Pressure connectors

M-type connector with M20x1.5 thread (fig.3a).
 P-type connector with M20x1.5 thread (fig.4a).
 CM30x2 or CM20x1.5-type connector with flush diaphragm (fig.5a).
 RM-type connector with M20x1.5 thread and radiator.
 G1/2 -type connector with G1/2" thread (fig.6a).
 GP -type connector with G1/2" thread
 CG1/2 -type connector with G1/2" thread and flush diaphragm (fig.6c).
 CG1-type connector with G1" thread and flush diaphragm (fig.6e).
 RG-type connector with G1/2" thread and radiator
 W-type connector (mining connector)
 other connection types by arrangement

5.5.2. PR-29A, PR-29B. Pressure connectors

P-type connectors with M20x1.5 thread - fig. 1, 2, 3.
 C-type connector to mount together with a valve manifold - fig.3.
 Diaphragm seal connectors: see the "Information Cards" for the diaphragm seals.

5.6. Electrical connectors and ingress protection rating of case

PD-type electrical connector, DIN 43650, PG-11, PG-9 cable gland. IP65 rated (*PN-EN 60529:2003*)
 PZ-type terminal box, M20x1,5 cable gland. IP66 rated (*PN-EN 60529:2003*)
 PK-type cable connector. IP67 rated (*PN-EN 60529:2003*)
 SG, SGM-type cable connector. IP68 rated (*PN-EN 60529:2003*)

6. CONSTRUCTION. ELECTRICAL CONNECTIONS

6.1. Measurement Principles

The **PC-29**, **PC-29A**, **PC-29B** pressure transmitters, **PR-29**, **PR-29A**, **PR-29B** differential pressure transmitters and the **PC-29P**, **PC-29PA**, **PC-29PB** and **SG-25A**, **SG-25B** level probes operate by converting changes in the piezoresistive bridge, which are proportional to the measured pressure, into a standard current or voltage output signal.

The active sensing device is a silicon diaphragm with diffused piezoresistors, separated from the medium by an isolating diaphragm and manometric oil.

6.2. Construction.

The basic component of the transmitter and probe is the sensing module, in which the input pressure is converted into a electrical signal. The sensing modules are fitted with pressure-transmitting connectors (see p. 5.6).

The second element of the transmitter is an electronic unit which amplifies and standardizes the output signal. This is fitted with potentiometers which can be used to set the zero and the range positions.

The casing of the transmitters, made from $\varnothing 27$ pipe, is permanently mounted on the sensing module.7
 On the other side is mounted a electrical connector.

For the measurement of dense, chemically reactive, or high-temperature media, the transmitters are fitted additionally with various types of diaphragm seal connectors, depending on the type of medium and environmental conditions (details can be found in the catalogue cards "DIAPHRAGM SEALS").

6.3. Casing, Electrical Connections

6.3.1. The transmitters and the probes with PD-type electrical connector and PG-11 packing gland (fig. 1b). PD-connector is screwed to casing. By unscrewing and removing the connector, can be gained access to the potentiometers used to the zero and range setting.

6.3.2. The transmitters and the probes may be fitted with a **PK** cable connector (fig.1c), mounted similarly to the **PD** connector. The body of the connector contains a permanently fixed and sealed cable of standard length 3m (other lengths can be produced to order). The cable contains a capillary which connects one side of the measuring diaphragm to the atmosphere.

6.3.3. **PZ** type connector has a terminal box permanently mounted with the casing (figure 2). The box is closed with a lid. Mounted, on the inside, a terminal block equipped is with additional control terminals, connected to 1, 2 and 3 terminals.

PZ type connector has an internal, and in Exi version also external earthing terminal. To measure the output signal, connect a voltmeter to control terminals 2 and 3.

6.3.4. The transmitters can also be equipped with a SG type electrical connector (see fig.1e) or SGM type electrical connector (with G1/2" thread) (see fig.1f), which provide degree of protection IP68.

Cable with a capillary, as in the connector PK, is used for connection of the measuring diaphragm to the atmosphere. For transmitters with cable connections SG and SGM does not have access to the potentiometers zero and span.

7. PLACE OF INSTALLATION OF TRANSMITTERS

7.1. General note

7.1.1. The transmitters can be installed both indoors and outdoors. It is recommended that transmitters intended for outdoor use be placed in a box or under cover.

There is no need for a cover in the case of transmitters with **PZ**, **PK** and **PKD** type connectors.

7.1.2. The place of installation should be chosen in such a way as to allow access to the device and to protect it from mechanical damage. In planning the installation of the transmitter and configuration of the impulse lines, attention should be paid to the following requirements:

- The impulse lines should be as short as possible, with a sufficiently large cross-section, and free of sharp bends, in order to prevent blockages;
- Where the medium is a gas, the transmitters should be installed above the measuring point, so that condensation flows down towards the site of the pressure measurement; where the medium is a liquid or where a protective liquid is used, the transmitters should be installed below the place where the pressure measurement is taken;
- The impulse lines should be inclined at a gradient of at least 10cm/m
- The levels of filling liquid in the impulse lines should be equal or kept constant difference,,
- The configuration of the impulse lines and the valve connection system should be chosen with regard to the measurement conditions and to requirements such as the need to reset the transmitters in position and the need for access to the impulse lines during water or gas removal and flushing



7.1.3. **Where there is a risk of heavy objects hitting the instrument (resulting, in extreme cases, in a part of the system with transducers being torn off and medium leakage), appropriate means of protection should be applied for safety reasons and to avoid the possibility of sparking or other, more appropriate location should be selected for the transmitter.**



7.2. Low Ambient Temperature



When the solidification point of the liquid whose pressure is being measured is greater than the ambient temperature, steps should be taken to protect the measurement apparatus from freezing effects.

This is particularly important in the case open-air installations. Protection by filling the impulse lines with a ethylene glycol and water mixture, or another liquid whose solidification point does not exceed the ambient temperature is obtained. The transmitter case and lines thermal insulation protects from short exposure to low temperatures only. Where the temperature is very low, the transmitter and impulse lines should be heated.

7.3. High Medium Temperature.

The transmitters may be used to measure media with temperatures of up to 120°C.

To protect the sensing module from temperatures in excess of 120°C, suitably long impulse lines are used to disperse the heat and to lower the temperature of the module.

Where it is not possible to use impulse lines of the required length, transmitters with remote diaphragm seals should be used (see catalogue cards "DIAPHRAGM SEALS").



Data as per Appendix Exi.ATEX or Appendix Exi.IECEx apply for the Exi version.

7.4. Mechanical Vibration, Corrosive Media

7.4.1. Transmitters should correctly work with vibrations with amplitudes to 1,6 mm and accelerations to 4g. If strong vibrations are carried via the pressure line and disturb of measuring, use should be made of elastic pulse lines or transmitters with a remote diaphragm seal.

7.4.2. Transmitters should not be installed in places where the diaphragm, made of 1.4404 / 1.4435 (316L) steel, would be subject to corrosion by the medium being measured



If possible, transmitters with diaphragms made of Hastelloy C276 should be used, or other means of protection applied (e.g. in the form of a separating liquid) or transmitters with diaphragm seals adapted for measuring aggressive mediums according to catalogue cards "DIAPHRAGM SEALS") should be used.

8. INSTALLATION AND MECHANICAL CONNECTIONS.

8.1. The **PC-29, PC-29A, PC-29B** transmitters can be mounted directly on rigid impulse lines.

Where connectors are used as in figures 3a, 4a, 5a, 6a, 6c, 6e it is recommended that connection sockets be used as shown in figure.3b, 4b, 5b, 6b or 5c, 6d, 6f.

Where the connectors are as in figures 4a, 5a and 6c, 6e rectangular gaskets are used with each transmitter. The socket shown as in figure 5c, 6d and 6f can be obtained from the manufacturer.

The material of the seal is selected based on the pressure value and the type and temperature of the medium.

If the pressure is applied via a flexible plastic tube, the transmitter should be mounted on a support with Red Ø6-M reduction.

In case of metal pipes, the used connections should comply with PN-82/M-42306.

The types of the impulse tubes are to be selected depending on the measured value of the pressure and the medium temperature.

8.2. The **PR-29, PR-29A, PR-29B**, transmitters can be mounted directly on rigid impulse lines.

To connect the basic versions of transmitters, with two M20 x 1.5 stubs (P-type connector), one can use (for example) straight connecting elements with nuts.

If the pressure is carried via a flexible plastic tube, use a reduction elements "Red Ø6-M" (M20x1,5 / Ø6).

The transmitters with connecting cover (C-type connector) are designed for installation on 3-valve or 5-valve manifolds, to a 2" pipe or to a flat surface using an fastener C2 (figure 11) or "U" (figure 12).

8.3. The transmitters can operate in any position.

When installed on an object with a high-temperature medium, it is advantageous to mount the transmitter in a horizontal position with the packing gland pointing downwards or to the side, in such a way that the transmitter is kept away from the stream of rising hot air.

Examples of the use of Aplsens assembly components to isolate the transmitters from high temperature media are shown in figure 13.

The horizontal assembly should be apply in case of transmitters with radiators.

When the measurement range is small, the reading can be affected by the position of the transmitter and by the configuration of the impulse lines and the way in which they are filled with liquid.

This error can be corrected using the zero-setting function.

8.4. In selecting assembly components, it may be helpful to consult information on Aplsens connection elements, reduction elements, sockets, valves, reduction clamps and signal tubes.

Information on this subject can be found in the catalogue cards "FITTING ACCESSORIES"

Pressure may be transmitted to the installed device only after checking that it has a measurement range which properly corresponds to the value of the measured pressure, that gaskets have been properly selected and fitted, and the connector has been properly screwed tight.

Attempts to undo the screws or fixing connector pipes on a transmitter under pressure may cause the medium to leak and create hazards for the personnel.



When disassembling the transmitter, it is necessary to disconnect it from the process pressure or bring the pressure to atmospheric level, and to take particular care and precautions in case of media which are highly reactive, caustic, explosive or otherwise hazardous to personnel. If necessary, rinse out this part of the system.

Transmitters with flange diaphragm seals are to be installed on the corresponding counter flanges on the facility.



It is recommended that the user matches the screw joints material to the pressure, temperature, flange material and seal to ensure tightness of the flange joint in the expected operating conditions.

Coarse-threaded screws complying with ISO 261 are to be used for flanges used in the transmitters.

Additional data concerning the diaphragm seals are specified in the catalogue cards "DIAPHRAGM SEALS".

9. ELECTRICAL CONNECTION

9.1. General recommendations

It is recommended that twisted pair cabling be used for the signal lines. If the transmitter and signal line are subject to a large amount of electromagnetic interference, then screened twisted pair cable should be used. The signal wires should not run alongside network power supply cables or near to large electrically-powered devices.

The devices used together with the transmitters should be resistant to electromagnetic interference from the transmission line in accordance with compatibility requirements.

It is also beneficial to use anti-interference filters on the primary side of the transformers, the power supplies used for the transmitters and apparatus used in conjunction with them.

9.2. Connections for transmitters with PD-type connector

The transmitters and the probes fitted with **PD** type connectors are to be connected as shown in diag.1a. Cable outlet can be set in any direction by slightly loosening the union nut connection to the transmitter housing. The section of the signal cable leading to the cable gland should be formed as a protective loop which the lowest point will lower than input to the cable gland to prevent a condensed water of running down towards the gland. Type PD connectors correctly mounted should have a tightened: the gland nut, nut connections for steel housing and screw connection linking the two parts.

9.3. Connections for transmitters with PK, PKD, SG, SGM -type connector.

The electrical connections transmitters equipped with connector **PK, PKD, SG** or **SGM** shall be carried out via the junction box with cable gland, in which the transmitter's cable connects with rest of the signal line.

The junction box should have an opening "breathable" equalizing pressure inside the can to atmospheric pressure.

Description of signal wires for transmitters with connector type **PK, PKD, SG** or **SGM** is shown on Fig,1c, 1e, 1f, 1g.

9.4. Connections for transmitters with terminal box (PZ-type connector).

The transmitters with **PZ**-type connectors should be connected by linking the signal wires to a terminal block, as shown in figure 2. Carefully screw in the cover and cork of the packing gland, making sure that the wire is tightly packed. Where necessary, the packing gland should be further sealed as described in 9.2.

9.5. Protection from excess voltage

Protection from excess voltage between the wires of the transmission line is provided by TVS diodes installed in all types of transmitter. In transmitters with PZ connections, in standard additional arresters are installed.

In the normal version and the "Version SA" - Ex installed additional protectors.

9.6. Earthing

Transmitters with PD or PK connections have a neutral cable (connected to the casing), which can be used only as a functional earthing. It should not be used for protective grounding or as a compensation connection. If the transmitter has, through the pressure connection, a good plating connection to properly grounded a metal pipe or tank, additional ground is not necessary. Transmitters with PZ connection are fitted with internal and external earth terminals, to which can be connected a protective or compensatory cables.

Shields of the connecting cables for transmitters with PK, PKD, SG, SGM cable connectors are led out for the user's disposal.

10. SETTING OF ZERO POSITION AND MEASUREMENT RANGE

The transmitter is factory regulated for the measurement range stated in the order.

After it has been installed, it may become necessary for the zero position to be changed.

The way of gaining access to the control knob is described in 6.3.

To perform the regulation, connect and power the transmitter in accordance with its technical parameters.

Supply a pressure equal to the lower limit of the measurement range, and make the output signal equal to 0V by turning the "zero" potentiometer. Turn the knob to the right to increase, and to the left to reduce the output signal.

After the zero position has been set, supply a pressure equal to the upper limit of the range, and use the "range" potentiometer to make the output voltage equal U_{out} .

Recheck the zero position, and repeat the procedure if necessary.

Most of the pressure transmitters measures the pressure in relation to atmospheric pressure, for those applications to zero adjustment is should be given atmospheric pressure to the measuring transmitter diaphragm and make the necessary adjustments. When adjusting the "zero" for the other performances of transmitters, such as transmitters with the shifted of measuring signal, or the absolute pressure transmitters, to zero regulations is necessary to use the appropriate pressure.

i Potentiometers can be used to shift the zero position and the range by up to 10%, without altering the setting.

11. SERVICES AND SPARE PARTS

11.1. Periodic service

Periodic service should be made in accordance with the regulations to which the user is subject

During inspection, the pressure connectors should be checked for loose connections and leaks, the electrical connectors should be checked with regard to tightness and the state of the gaskets, and the diaphragm seals should be checked for tarnishing and corrosion. The conversion curve should also be verified.

11.2. Unscheduled services

If the transmitters or probes are installed in a location where they may be exposed to mechanical damage, excess pressure, hydraulic impulses or excess voltage, or the diaphragm may be in danger from sedimentation, crystallization or erosion, inspections should be carried out as required.

i The diaphragm should be inspected and cleaned, the protective diodes should be checked for shorting, and the conversion curve should be verified.

Where it is found that the signal in the transmission line is absent or its value is incorrect, a check should be made on the line and its terminal connections. Check whether the values of the supply voltage and load resistance are correct. If the line is in order, check the operation of the transmitter.

After checks have been made, take steps to eliminate the faults detected.

11.3. Cleaning the Diaphragm Seal, Overloading Damage.

11.3.1. Sediment and dirt which have formed on the diaphragm in the course of operation must not be removed by mechanical means, as this may damage both the diaphragm and the transmitter itself.

The only permitted method is the dissolving of sediment.

11.3.2. Sometimes transmitters malfunction due to damage caused by overloading, e.g. in case of:



- application of excessive pressure;
- freezing or solidification of the medium;
- action of a hard object, such as a screwdriver, on the diaphragm

11.4. Spare parts

The following transmitter parts may need replacing due to damage or normal wear:

PD connector – terminal block with angular cover and seal, connector base with seal, rating plate, case.

PK connector – the entire connector.

PZ connector – cover seal and packing gland.

In the Exi version, the user may replace only the terminal block with angular shield and the seal in the PD connector, or the seal and packing gland in the PZ connector.

i Other parts, due to their special characteristics and anti-explosive requirements, may be replaced only by the manufacturer or an authorized firm.

12.5.3. Earthing.

The probes with PD and PK connectors, if excess voltage protection is fitted, the probe's extension tube should be earthed.

The **PC-29PA**, **PC-29PB** probes with PZ connectors should be earthed via the internal or external earth terminal.

The **PC-29** probes with PZ connectors should be earthed via the internal earth terminal.

13. HYDROSTATIC LEVEL PROBES SG-25, SG-25A, SG-25B.

13.1. Applications

The **SG-25**, **SG-25A**, **SG-25B** probes are designed to measure the depth of liquid in wells, swimming pools, watercourses, boreholes etc.

The probes convert an input pressure (being a measure of the level of the medium into voltage signal $0 \div U_{out}$ in a three-wire system.

13.2. Technical Data

Any measurement range	1...500 m H ₂ O for normal version 1...100 m H ₂ O for Exi version
Recommended standard ranges	4, 10, 20, 50, 100 m H ₂ O

	Measurement Range		
	1 m H ₂ O	4 m H ₂ O	0...10m H ₂ O ÷ 500 m H ₂ O
Overpressure Limit (repeatable–without hysteresis)	40 x range	25 x range	10 x range (max. 700 mH ₂ O)
Accuracy	0,6%	0,3 %	0,2 %
Thermal error	typical 0,3% / 10°C max 0,4% / 10°C		typical 0,2% / 10°C max 0,3% / 10°C

Special version with increased accuracy (SG-25, SG-25A, SG-25B level probes, measurement range 0...10 mH₂O, accuracy - 0.1%, Total error at 0...25°C - 0.3%)

Hysteresis, repeatability	0,05%
Long term stability	0,1% or 1 cm H ₂ O for 1 year
Thermal compensation range	0° ÷ 25°C – standard -10° ÷ 70°C – for special version
Medium temperature range	-25° ÷ 50°C – for ranges > 20 m H ₂ O -25° ÷ 75°C – for ranges ≤ 20 m H ₂ O



Maximum process temperatures for Ex version see “Appendix Exi.ATEX” or “Appendix Exi.IECEX.”



The medium must not be allowed to freeze in the immediate vicinity of the probe.

13.2.1. SG-25, SG-25A, SG-25B. Electrical parameters: as in p. 5.2.

13.2.2. SG-25, SG-25A, SG-25B. Construction Materials

Diaphragm	:	Hastelloy C276, Stainless steel 1.4435 (316L)
Sensing module:		Stainless steel 1.4404 (316L)
Casing for electronic parts		Steel pipe 1.4404 (316L)
Liquid filling the interior of the sensing module		Silicone oil

13.3. Principles of Operation. Construction

The **SG-25**, **SG-25A**, **SG-25B** hydrostatic level probes work by converting changes in the resistance of a piezoresistive bridge, which are proportional to the pressure (of a hydrostatic column of liquid), into a output signal. The active sensing device is a silicon diaphragm with in-diffused piezoresistors.

13.4. SG-25, SG-25A, SG-25B. Place of installation.

The level probes installed in places where liquid levels are measured in wells, swimming pools, tanks, boreholes etc. The probe is immersed in the medium being measured. A special cable extends above the level of the medium; this can be connected directly to another device or to a terminal box.



The medium must not be allowed to freeze in the immediate vicinity of the probe.
Inspect the diaphragms, to prevent the formation of precipitates, blockages, etc.
Impurities removed only by dissolving or rinsing.

The probe can be suspended from the power supply cable e.g. using the handle SG prod. Aplsens. If the probe will often be removed or, when during the pull, there is the possibility of hitching protruding elements it is recommended to suspend the probe on a steel cable using the supporting handle. If the cable is to be exposed to current or turbulence, it should be installed in a protective tube, e.g. one made from PCV.



Directly before location the probe in measured medium to take off from diaphragm seals SG-25, SG-25A, SG-25B the securing covers.
Protect the level probe from impacts during installation.

13.5. Electrical Connection. Settings

The **SG-25** level probes should be connected as shown in Fig.15



SGE-25A, SG-25B probes in version Exi connected according to Appendix Exi.ATEX or Appendix Exi.IECEx.

The **SG-25, SG-25A, SG-25B** are factory set to the range stated in the order. The user does not have access to the "zero" and "range" potentiometers. Setting may be adjusted by the manufacturer only.

14. PACKING, STORAGE AND TRANSPORT

14.1. The transmitters and probes should be packed singly or in sets, in such a way as to protect them from damage during transportation.

Transmitters with uncovered diaphragm or seal connectors, stored without packaging, should have covers to prevent damage to the diaphragm.

The cable of **SG-25, SG-25A, SG-25B** probes should be rolled into a loop ≥ 300 mm in diameter, secured so as to prevent the coils from moving relative to each other and the whole from moving within the package. Avoid breakage to the cable at the point where it enters the cable gland.

The devices should be stored in multiple packs under cover, in a place free of vapours and reactive substances, with an air temperature between +5°C and +40°C, and relative humidity of not more than 85%.

During transportation, the transmitters should be packed and secured so as to prevent them from shifting. Any means of transport may be used, provided direct atmospheric effects are eliminated.

14.2. The **PC-29P, PC-29PA, PC-29PB** probes are individually packed. Individually packed probes are bound in packages containing several probes. Storage and transport as above.

15. GUARANTEE

Manufacturer warrants under the conditions specified in the Product Certificate which is also a guarantee card.

16. SCRAPPING, DISPOSAL

Waste or damaged transmitters should be dismantled and disposed of in accordance with Directive (2002/96/EC) on waste electrical and electronic equipment (WEEE) or returned to the manufacturer.

17. ADDITIONAL INFORMATION

The manufacturer reserves the right to make constructional and technological changes which do not lower the quality of the transmitters and probes.

17.1. Related documents

Catalogue Cards "Diaphragm seals"

17.2. Related standards

PN-EN 60529:2003	Degrees of protection provided by enclosures (IP Code)
PN-EN 61010-1:2004	Safety requirements for electrical equipment for measurement, control and laboratory use. General requirements
PN-82/M-42306	Screwed connectors of pressure gauges
PN-81/M-42009	Automatics and industrial measurements. The packing, the storage and transport of devices. General requirements
PN-EN 1092-1:2004 (U)	Flanges and their joints – Circular flanges for pipes, valves, fittings and accessories. – Part 1: Steel flanges.
Standards for Exi version	See – „Appendix Exi.ATEX” or „Appendix Exi.IECEX”

18. FIGURES

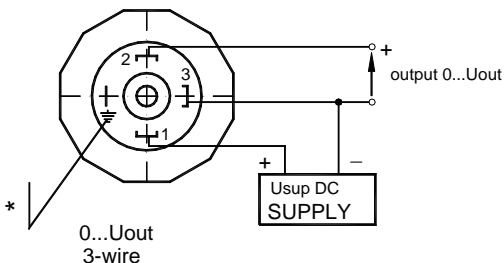

***) Functional earth terminal not to be used as a protective terminal.**

Fig.1a. Wiring diagram transmitters and probes (Not applicable Exi version)

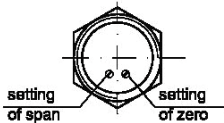

Fig.1d
View of potentiometers
of zero and span (PD, PK, PKD)

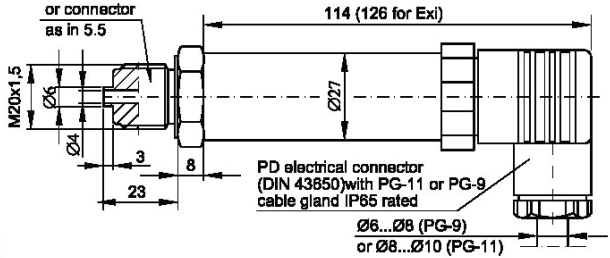

Fig.1b. PC-29, PC-29A, PC-29B transmitter with PD connector

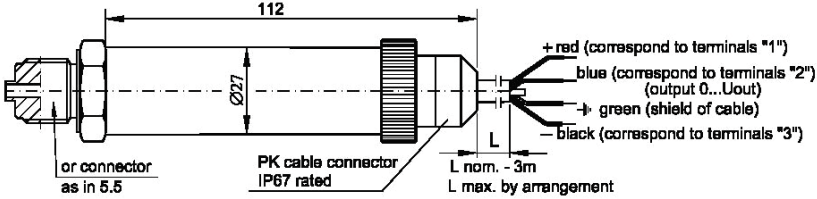

Fig.1c. PC-29, PC-29A, PC-29B transmitter with PK connector

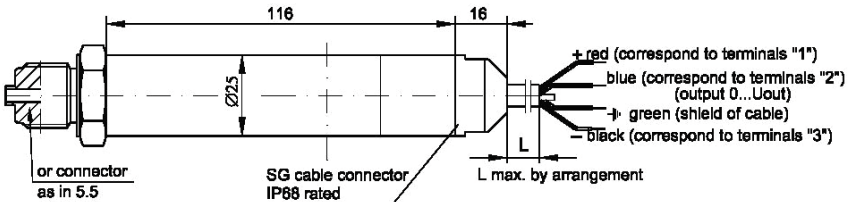

Fig.1e PC-29, PC-29A, PC-29B transmitter with SG connector

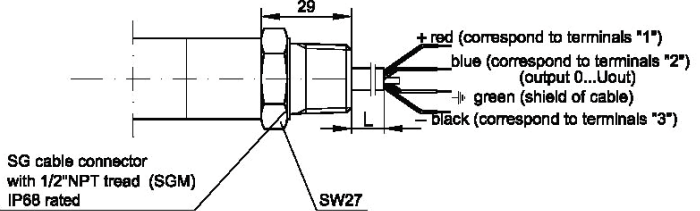

Fig.1f PC-29, PC-29A, PC-29B transmitter with SG connector with 1/2"NPT tread (SGM)

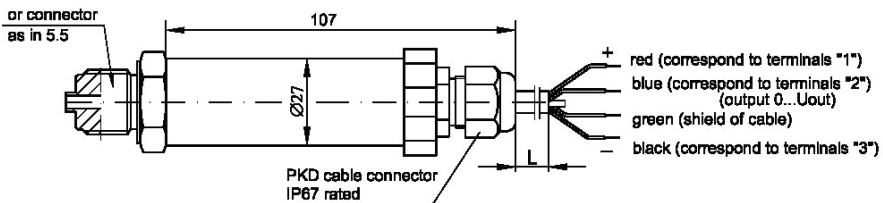
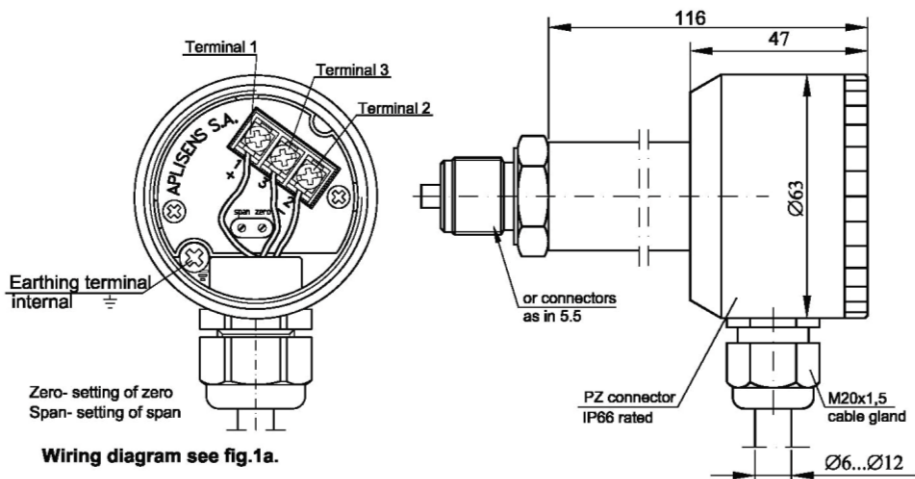

Fig.1g PC-29, PC-29A, PC-29B transmitter with PKD connector

Fig.1. PC-29, PC-29A, PC-29B transmitters with PD, PK, PKD, SG, SGM connectors: dimensions and methods of connection



Wiring diagram see fig.1a.

Sign of terminals

Terminal 1 - Supply "+" (plus)

Terminal 2 - Output signal "+"

Terminal 3 - Supply "-" (minus); output signal "-"

Fig.2. PC-29, PC-29A, PC-29B transmitters with PZ. Dimensions

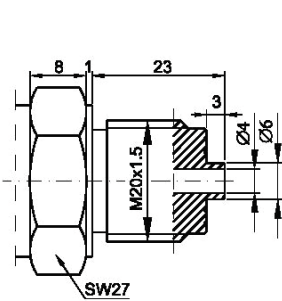

Fig.3a. M-type connector with M20x1.5 thread

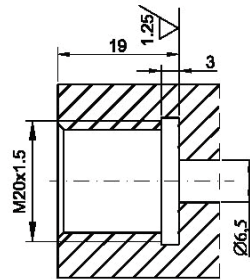

Fig.3b. Socket for M-type connector.

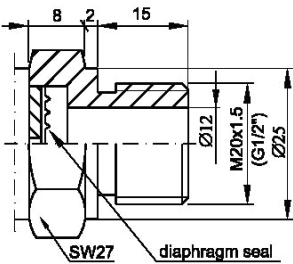

Fig.4a. P-type connector with M20x1.5 thread

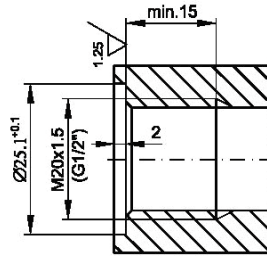

Fig.4b. Socket for P-type connector.

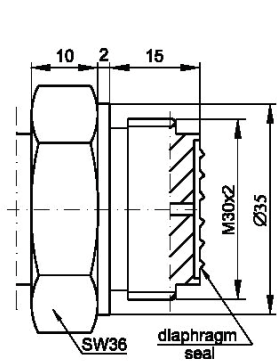

Fig.5a. CM30x2-type connector with flush diaphragm with M30x2 thread

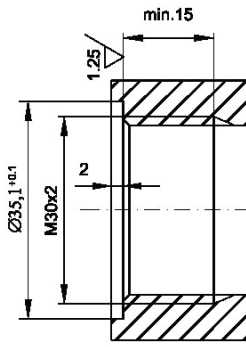

Fig.5b. Socket for CM30x2-type connector

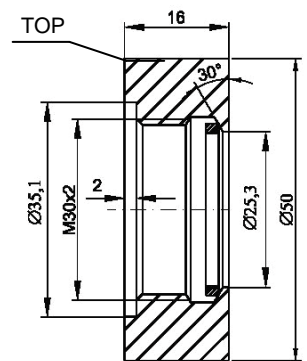

Fig.5c. Weldable fitting ring for CM30x2-type connector
Sealing: teflon



The ring in Fig.5c must be welded in place with the word TOP upwards

Order code Socket CM30x2

Fig.3. M-type connector with M20x1.5 thread

Fig.4. P-type connector with M20x1.5 thread

Fig.5. CM30x2-type connector with flush diaphragm with M30x2 thread

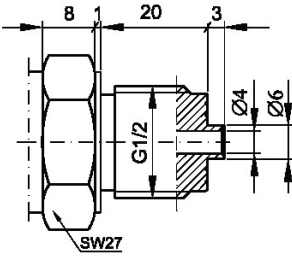

Fig.6a. G1/2-type connector with G1/2" thread

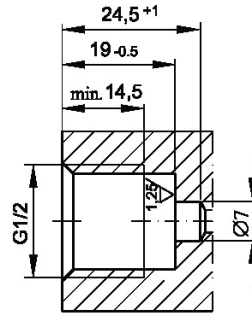

Fig.6b. Socket for G1/2-type connector

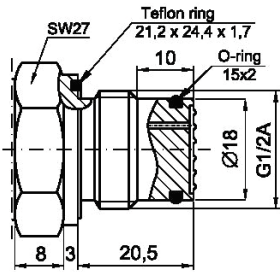

Fig.6c. CG1/2 -type connector with flush diaphragm with G1/2" thread,

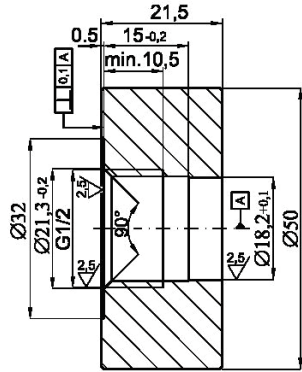

Fig.6d. Weldable fitting ring for CG1/2 - type connector
Order code Socket CG1/2

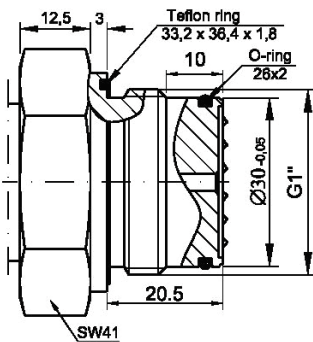

Fig.6e. CG1-type connector with flush diaphragm with G1" thread,

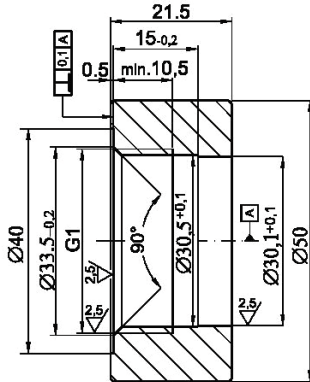

Fig.6f. Weldable fitting ring for CG1 - type connector
Order code Socket CG1

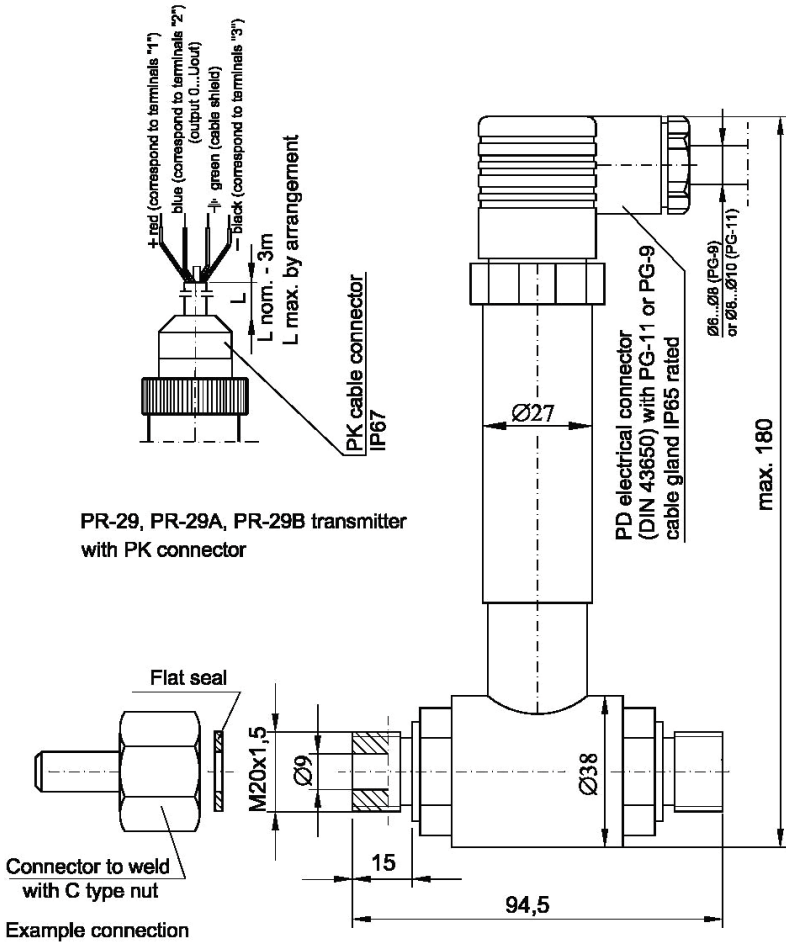

Fig.7. PR-29, PR-29A, PR-29B differential pressure transmitter with PD, PK connectors Dimensions.

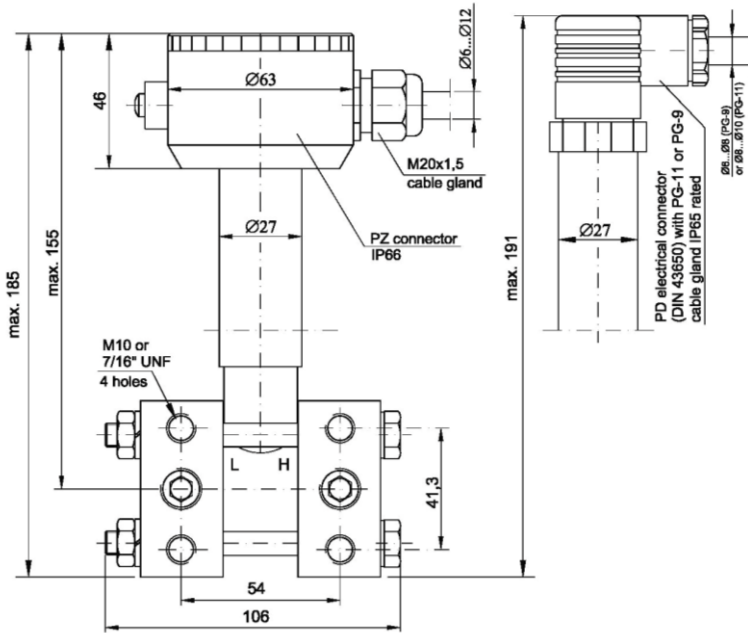

Fig.8. PR-29, PR-29A, PR-29B differential pressure transmitter with C-type process connection to be mounted together with valve manifold

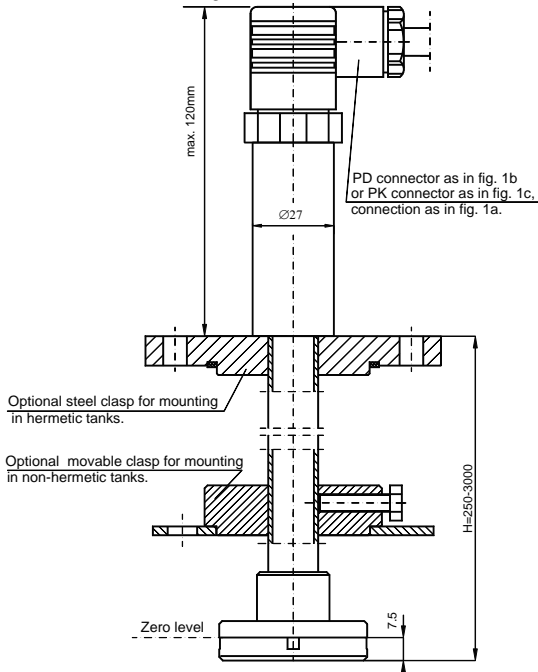

Fig.9. PC-29P, PC-29PA, PC-29PB level probes

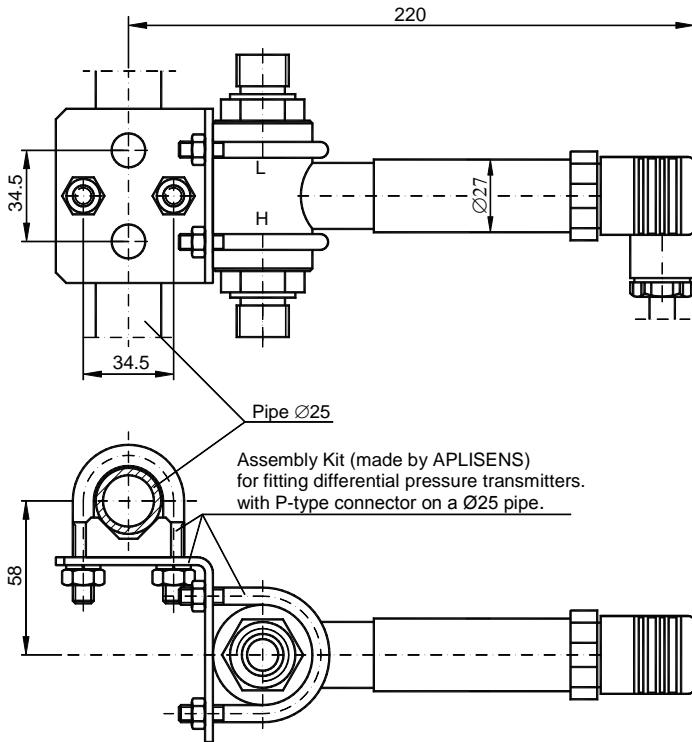

Fig.10. Example: how to install the PR-29, PR-29A, PR-29B differential pressure transmitter

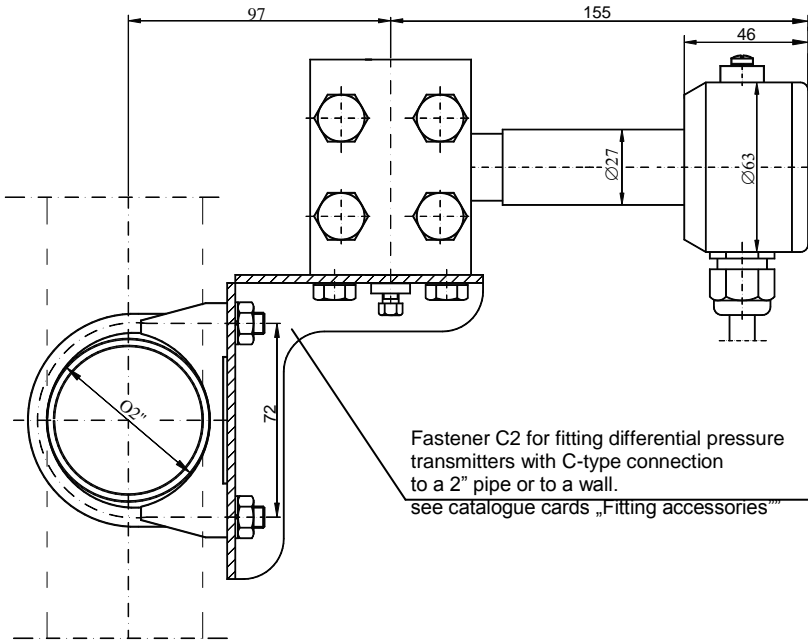

Fig.11. Example: how to install the PR-29, PR-29A, PR-29B transmitter on a vertical or horizontal pipe.

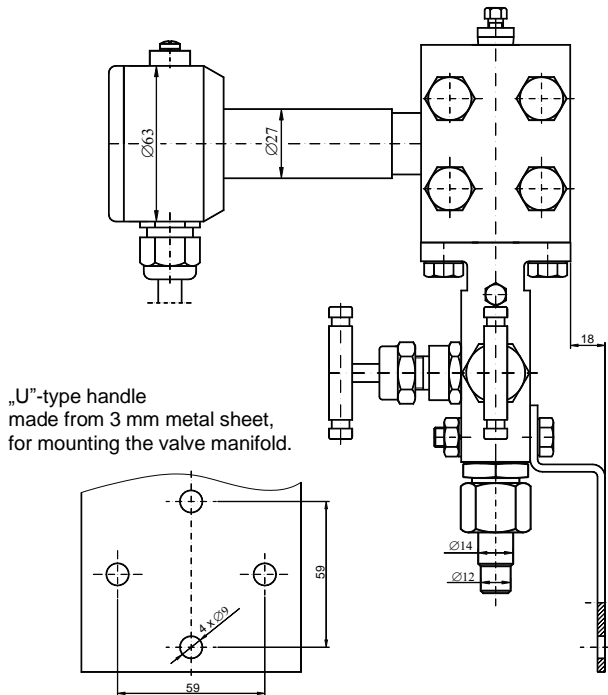

Fig.12. Example: how to install the PR-29, PR-29A, PR-29B transmitter with a valve manifold to a wall

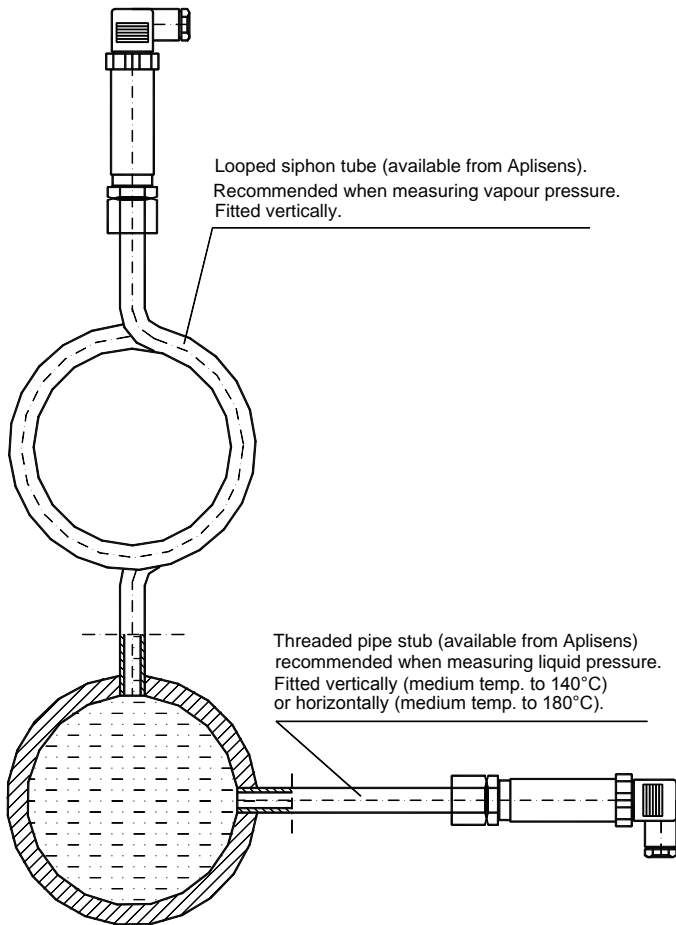

Fig.13. Possible methods of isolating the transmitter from high temperatures

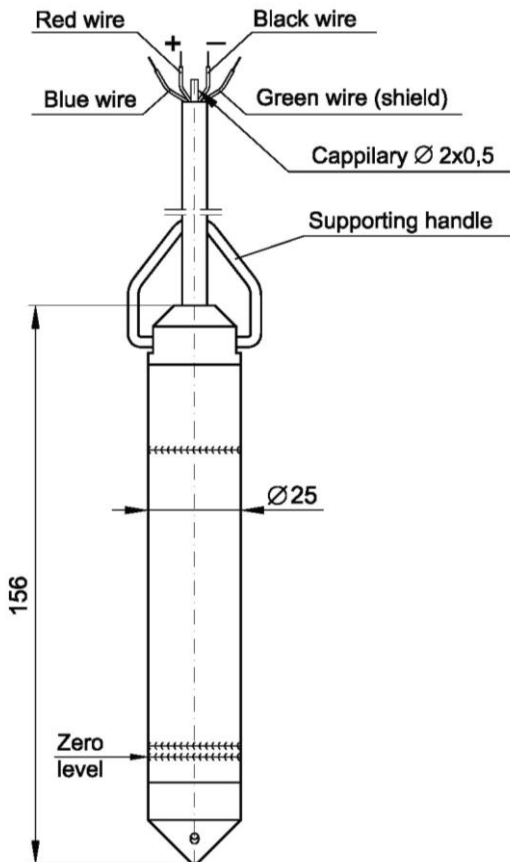

Fig.14. SG-25, SG-25A, SG-25B probes. Dimensions

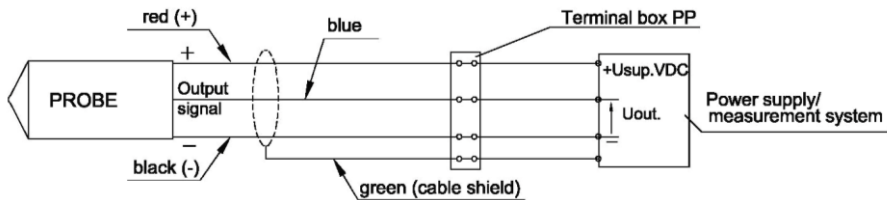

Fig.15. Wiring diagram SG-25, SG-25A, SG-25B probes.

